

MODULE 4 - LIFTING AND RIGGING

INTRODUCTION

A fire officer on a pumper was once asked why he ordered the pumper engineer to drive the 30,000 pound fire apparatus on a road that had a bridge with a 10,000 load limit. The officer responded to the question by saying that "it was an emergency". Rescue personnel often think that the physical laws of the universe do not apply when there is "an emergency". Gravity is one of the laws of the universe that applies to all earthly (rescue) environments. Rescuers deal with gravity every time they lift a patient, every time they move an object and every time they lower themselves on a rope.

Rescuers need to understand the relationship of gravity to basic tactical evolutions such as lifting, lowering, moving and stabilizing loads. Today even with the availability of powerful cranes, strong hydraulic winches and high pressure air bags there is a need for a knowledge of the basic concepts of leverage and gravity. It is the ability of the rescuer to make effective size ups in confined areas of collapsed buildings that often means the difference between life and death.

The rescuer also has a critical role to play when using the heavy lifting equipment such as cranes. All loads to be lifted or moved must be assessed for weight, stability and rigging points. The rescuer's knowledge of rigging equipment and its basic application will enhance the ability of the heavy equipment to perform.

This training module for the US&R Structural Collapse Technician will look at levers, gravity, lifting and rescue rigging equipment.

TERMINAL OBJECTIVE

- To understand the relationship of gravity and movement as they apply to urban search and rescue operations.

CLASS INTRODUCTION

- Introduction of instructors
- Instructor/student contract
- Schedule of events
 - classroom lecture
 - practical evolutions
 - rotation schedule/site location
- Personal protective gear requirements

CLASS INTRODUCTION

- Safety considerations
- Evaluations
- Feedback

TERMINAL OBJECTIVE

- To understand the relationship of gravity and movement as they apply to urban search and rescue operations.

MODULE 4 - LIFTING AND RIGGING

ENABLING OBJECTIVES

At the conclusion of module the student should be able to:

- Understand the basic physics as they relate to mass, gravity, and center of gravity.
- Understand moment of force considerations as they relate to the movement of stationary objects.
- Explain the concept of elasticity of solids.
- Describe what determines the efficiency of mechanical advantages.
- Explain the three classes of levers.
- Describe the efficiency of inclined planes.
- Describe the two types of pulley configurations.
- Explain the effective use of high pressure air bags.
- Calculate the weights of common materials.
- Explain the use of anchor systems, anchor failure considerations, and proper anchor spacing.
- Describe the proper use of swivel hoist, steel angle brackets, and concrete screws.
- Understand the proper use of wire ropes, wire rope fittings, end terminations, and tighteners.
- Explain the use of slings and sling arrangements.
- Describe the use of chains for rigging and lifting.
- Determine the effects of critical angles as they relate to lifting and moving objects.
- Identify and describe the advantages and disadvantages of the different types of cranes.
- Explain considerations for crane use, and demonstrate basic crane signals for rescue operations

ENABLING OBJECTIVES

At the conclusion of module the student should be able to:

- Understand the basic physics as they relate to mass, gravity, and center of gravity.
- Understand moment of force considerations as they relate to the movement of stationary objects.
- Explain the concept of elasticity of solids.
- Describe what determines the efficiency of mechanical advantages.
- Explain the three classes of levers.
- Describe the efficiency of inclined planes.

ENABLING OBJECTIVES

At the conclusion of module the student should be able to:

- Describe the two types of pulley configurations.
- Explain the effective use of high pressure air bags.
- Calculate the weights of common materials.
- Explain the use of anchor systems, anchor failure considerations, and proper anchor spacing.
- Describe the proper use of swivel hoist, steel angle brackets, and concrete screws.
- Understand the proper use of wire rope, wire rope fittings, end terminations, and tighteners.

ENABLING OBJECTIVES

At the conclusion of module the student should be able to:

- Explain the use of slings and sling arrangements.
- Describe the use of chains for rigging and lifting.
- Determine the effects of critical angles as they relate to lifting and moving objects.
- Identify and describe the advantages and disadvantages of the different types of cranes.
- Explain considerations for all crane use.
- Demonstrate basic crane signals for rescue operations.

MODULE 4 - LIFTING AND RIGGING

UNIVERSAL GRAVITATION and CENTER of GRAVITY

PRINCIPLE

- Every particle in the universe attracts every other particle with a force proportional to their combined mass, and inversely proportional to the square of the distance between them.
 - There is no exception to gravity.
 - All objects seek a state of equilibrium.
 - Gravity effects such evolutions as:
 - Lifting
 - Lowering
 - Stabilizing

CENTER OF GRAVITY (CG) AND POSITION CHANGES

- Center of gravity: Point at which the whole weight of object is acting vertically downward = balance.
- Load's weight is perfectly balanced or distributed around the center of gravity.
- If a load is suspended at its CG, it can be turned in any direction with little effort.
- If load is lifted to the right/left of CG, it will tilt at an angle.
- If a load is lifted below its center of gravity, the weight of the load will be above the lifting point, and the load will tip over.
- Important that loads be hoisted above the load's CG.
- CG of a solid object is located in three planes or directions:
 - X axis = Horizontal, side to side
 - Y axis = Vertical axis
 - Z axis = Horizontal, front to back

EXAMPLE OF CG:

A solid piece of concrete that is 10ft long x 4ft wide x 6ft high has it's CG at a point that is 5ft from the end, 2ft from the front, and 3ft from the bottom

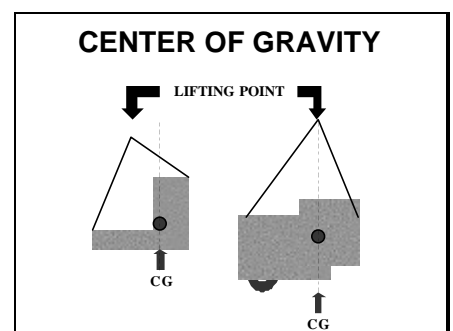
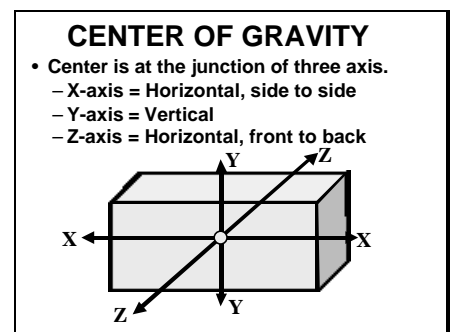
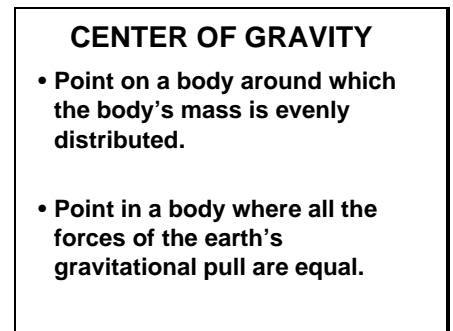
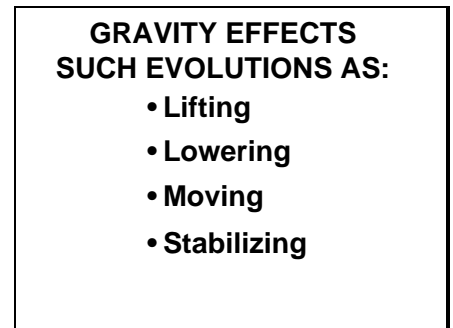
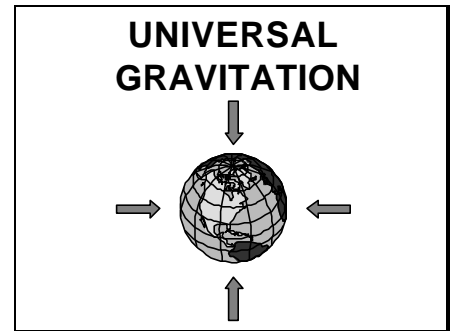

MODULE 4 - LIFTING AND RIGGING

EQUILIBRIUM

PRINCIPLE:

- Every object resting on earth is said to be “at rest” and in a state of Static Equilibrium. All objects seek a state of equilibrium.

CHANGING EQUILIBRIUM

- Small outside force/effort at the highest point on the object can change it's condition from static to unstable equilibrium:
 - Wind or a gentle push can move the object out this "balance point" of static equilibrium.
 - With applied force changes into a state of unstable equilibrium.
 - Object will move (fall over) into another position of static equilibrium.

FRICTION and RESISTANCE FORCE

PRINCIPLE:

- Force found in the location of the contact between two surfaces.
- Force acts parallel to those surfaces in a direction opposing the relative motion between them.
- The greater the weight (force of gravity) of an object, the greater the friction force

BASIC CONCEPTS RELATED TO FRICTION

- The smoother the two contact surfaces, the less the friction between those surfaces
- Liquids can reduce the friction between two surfaces (unless too much surfacetension is developed)
- Materials with rounded surfaces that break the contact between objects will generally reduce friction

EQUILIBRIUM

- Every “at rest” object is in a state of Static Equilibrium.
- Forces can change Equilibrium
 - Wind or other lateral forces
 - Object will move to another position of Static Equilibrium

FRICTION

- Force located between two surfaces
- Force parallel to those surfaces in a direction opposing the relative motion between them
- The greater the weight, the greater the friction force

METHODS TO REDUCE FRICTION

- Liquids
- Rollers/Pipes/Wheels 
- Lift one side of object to reduce load on contact surface
- Reduce the size of a rough contact surface

MODULE 4 - LIFTING AND RIGGING

BASIC CONCEPTS RELATED TO FRICTION (continued)

- Reducing the size of the surface area between two objects may reduce the amount of friction present, especially if the contact surfaces are rough:
- Lifting operations often involve lifting only one side of the object which reduces the weight on the contact surface and consequently decreases the friction force.

FRICTION AND EQUILIBRIUM

- Friction may be the outside force acting on an object creating equilibrium.
- The rescuer can change the amount of friction holding an object in place and allow the force of gravity to overcome the forces of friction:
 - Rocking motion
 - Making surface smaller (tilt lift)
 - Reducing the weight on the contact surface

- Friction holding an object in place can be overcome by the force of gravity when an object is on an inclined plane.

APPLICATION OF MECHANICS TO COLLAPSE RESCUE

Inappropriate or ineffective use of rescue tools is often a result of a lack of understanding of mechanical advantage. The following is an overview of mechanics of rescue:

- **Mechanics** is the branch of physics dealing with energy and forces in relation to bodies.
 - Distance traveled and force used are two elements of work and energy.
- **Leverage** is the practical application of the moment of force principle.

METHODS TO REDUCE FRICTION

- Liquids
- Rollers/Pipes/Wheels 
- Lift one side of object to reduce load on contact surface
- Reduce the size of a rough contact surface

ENERGY AND WORK CONCEPTS

The effective use of rescue tools is often determined by a complete understanding of mechanical advantages systems and their application in a given situation.

MECHANICS

- The branch of physics dealing with forces and energy in relation to objects.
- Distance traveled and force used are two elements of work and energy.

MODULE 4 - LIFTING AND RIGGING

MOMENT OF FORCE CONSIDERATIONS

- Moment of force about a point (always a point) is weight (or force) multiplied by the distance away from the turning point of that weight or force.
- **Foot-pound** means of describing a Moment of Force
 - foot = distance
 - pound= force
 - force = any influence that can change the velocity of an object.
- When a force is applied that will cause rotation around a fulcrum (pivot point) = moment of force = foot-pounds.

ENERGY AND WORK CONCEPTS

ENERGY

- Property that gives something the capacity to do work.
- Something that is able (directly or indirectly) to exert a force on something else and do work on it.
- Types of energy:
 - kinetic
 - potential
 - rest

WORK

- Rate that something produces energy
- Horsepower is the measurement of work.
 - the movement of an object from one point to another within a given time.
 - force/distance per time = pounds moved feet within time
1 horsepower = 33,000 foot pounds per minute
(the ability to move a 33,000 lb object 1 ft in 1 minute)
- Need power to do work and must overcome friction, gravity/inertia, and air resistance

MOMENT OF FORCE CONSIDERATIONS

Moment of force about a point is the weight (or force) multiplied by the distance away from the turning point of that weight.

Moment of Force = Foot-Pounds

MOMENT OF FORCE CONSIDERATIONS

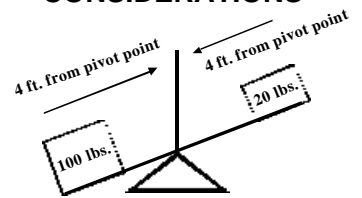

MOMENT OF FORCE CONSIDERATIONS

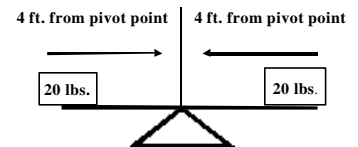

ENERGY

- **Foot-pound:** means of describing amount of work done.
 - Pound = force
 - Foot = distance
- When a force (pound) rotates around a fulcrum/pivot point at a distance (foot) = moment of force (torque) = ft-lbs

WORK

- Rate at which pounds are moved feet in specific time
 - Horsepower
 - force\distance\time measurement
 - 33,000 foot pounds per minute
- Need power to do work
 - must overcome friction, gravity and air resistance

MODULE 4 - LIFTING AND RIGGING

OVERVIEW OF MECHANICAL ADVANTAGE (MA)

MA

- Ratio between the output force a machine exerts to the input force that is furnished to that machine to do work.
- Defines how efficient and effective a machine is.
- Mechanical advantage greater than one (1) means that the output force (energy) delivered by the machine exceeds the input force (energy) supplied to the machine.
- Mechanical advantage less than one (1) means that the output force (energy) delivered by the machine is smaller than the input force (energy) supplied to the machine.
- Applied to the relationship between the weight of a load being lifted and the power of the force required to lift/push/hold that load.

SIMPLE MACHINES

- Consist of inclined planes, levers, pulley wheels, gears, ropes, belts, and/ or cams.
- Rigid or resistant bodies that have pre-defined motions.
- Capable of performing work.
- Energy applied to these mechanisms by a source that causes these mechanisms to perform useful motion.
- More efficient to perform work with machines than with muscle force only.
- We will now discuss Inclined Planes, Levers, Pulleys, and an advanced leverage application, the A frame Gantry

INCLINED PLANES

- Examples: Ramps, wooden wedge, screw thread
- Gains effectiveness of energy used based on distance traveled = mechanical advantage.
- Use of a gradual slope = less force to move an object a certain distance.

MECHANICAL ADVANTAGE DEFINITION

The ratio between the output force a machine exerts to the input force that is furnished to that machine to do work.

MECHANICAL ADVANTAGE EFFICIENCY

Mechanical advantages define the efficiency and effectiveness of a machine.



5 to 1
Output \ Input

MECHANICAL ADVANTAGE EFFICIENCY

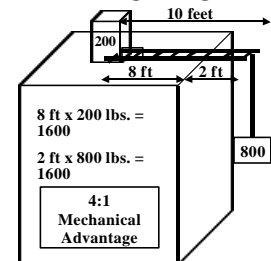

SIMPLE MACHINES CONSIST OF:

- Inclined Planes
- Levers/Pry bars
- Pulleys
- Gears
- Ropes
- Belts
- Cams



INCLINED PLANES

Gains efficiency by reducing required force to raise object

Less force - Same energy

Efficiency depends on the slope of the incline and the friction on it's surface.

MODULE 4 - LIFTING AND RIGGING

INCLINED PLANES (continued)

■ **Percentage of load based on slope and grade**

- When an object comes to rest on a slope, the rescuer must determine the percentage of the loads weight that needs to be managed during the stabilization process.
- To estimate the load percentage first determine the amount of resistance the load surface has in relation to the object.
- Discounting friction refer to the table below for approximate weight based on slope.

Slope/Grade	% of Load's Weight
45 degrees	100%
35 degrees	60 %
25 degrees	40%
15 degrees	25%

LEVERS

“Give me a lever long enough and a prop strong enough, I can single handed move the world.” Archimedes

■ **Application of levers:**

- Move a load that is heavier than can be moved by manpower alone.
- Pulling/hauling.
- Raising.

■ **Leverage is the means of accomplishing work with levers:**

- Transfers force from one place to another.
- Changes the force's direction.

CLASSES OF LEVERS

■ **Class One Lever**

- Fulcrum is placed between the force applied and weight (load).
- MA: Used when a decided advantage is desired.
- Examples: Crowbars, wrecking bars, pliers, scissors

APPLICATION OF INCLINED PLANES

- Ramps
- Wooden Wedges
- Screw Thread

INCLINED PLANES

Travel length divided by height = MA
 $13/5 = 2.6 = 2.6:1$ MA

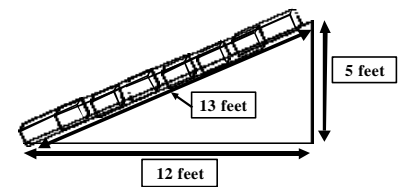

PERCENTAGE OF LOAD Based on slope & grade

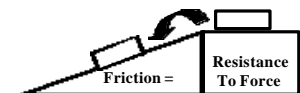

- 45 degrees 100%
- 35 degrees 60%
- 25 degrees 40%
- 15 degrees 25%

THE APPLICATION OF LEVERS

- Move, haul, or pull a load that would normally be outside of the human's power window.

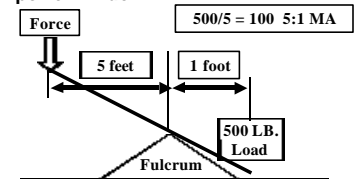

CLASS ONE LEVER

Fulcrum is placed between the force applied and the load.

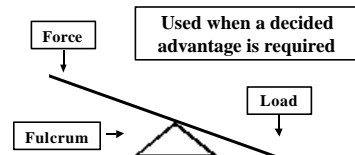

MODULE 4 - LIFTING AND RIGGING

CLASSES OF LEVERS (continued)

■ Class Two Lever:

- Weight (load) is placed between the force and the fulcrum.
- MA: Used for advantage in moving heavy materials on a horizontal/near horizontal surface.
- Examples: Wheelbarrows, furniture dollies

■ Class Three Lever:

- Force placed between the fulcrum and the load.
- MA: used when force may be sacrificed for distance.
- Examples: Brooms, shovels, baseball bat, tweezers

SCREW-TYPE MACHINES

- Examples of screw-type machines: Worm gears, screw jacks and valves in fire hydrants.
- Characteristics of these machines are:
 - Combination of a lever and an inclined plane.
 - Thread of a screw is an inclined plan encircling the stem of the screw.
 - Handle is the lever.
 - Thread works in a corresponding groove in the base.
 - Thread is forced to move under the load.
 - One rotation of the handle moves the thread through a distance equal to the distance between it and the thread below it.
 - Distance moved is call the pitch of the screw.

PULLEYS

- Application related to loads:
 - Lifting
 - Pulling
 - Moving
 - Change direction
 - Mechanical advantage
 - Reduce friction

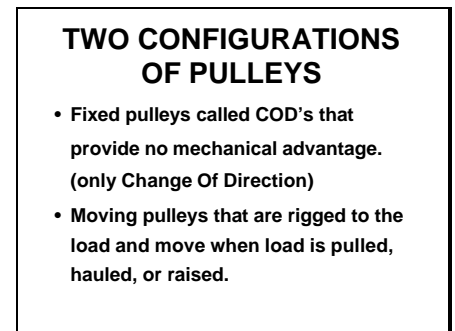
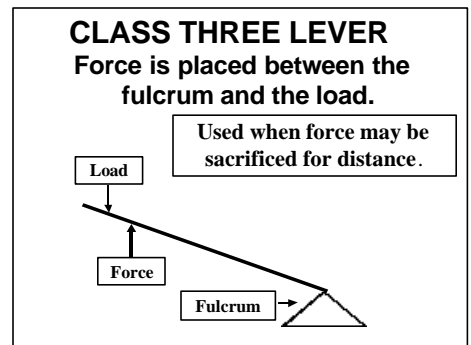
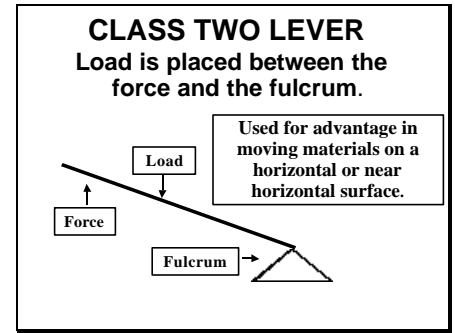

MODULE 4 - LIFTING AND RIGGING

PULLEYS (continued)

- Change direction of effort:
 - Pulley is stationary: Does not change theoretical mechanical advantage
- Gain mechanical advantage:
 - Pulley is moving: Changes mechanical advantage depending on use
 - Bitter end at the load — the simple system is odd
 - Bitter end at the anchor — the simple system is even

The difference between theoretical and actual mechanical advantage is "friction"

- What class of lever is a pulley?

ADVANCED LEVERAGE APPLICATIONS A-Frame Gantry

- The A-Frame Gantry is a fairly complex application of leverage that involves floating an object in air between two horizontal points.
- The application for the gantry is most practical during collapse situations involving the movement of objects where there are no suitable overhead anchor points and crane access is not practical.
- The A- frame may be made from two 6x6x14'-0" timbers that are lashed together at the top, or by using a pair of 12 ft long, aluminum rescue struts connected using special apex and foot connections.
 - The two lower ends of the A-frame must be connected together, just above the ground, using a stout rope, webbing or chain.
 - The legs should be spaced from 10 to 12 feet apart at the ground.
- A 15:1 or 20:1 compounded mechanical advantage pulley system used for swinging the A-frame is attached to the apex of the gantry and anchored to an appropriate bombproof anchors.

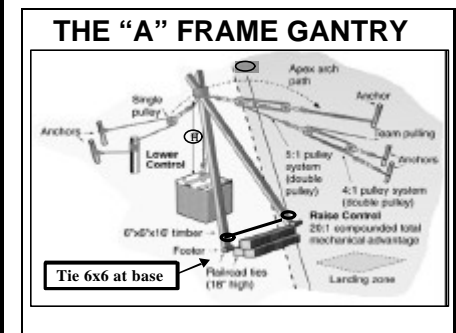
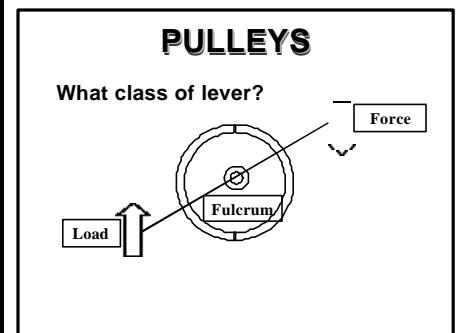
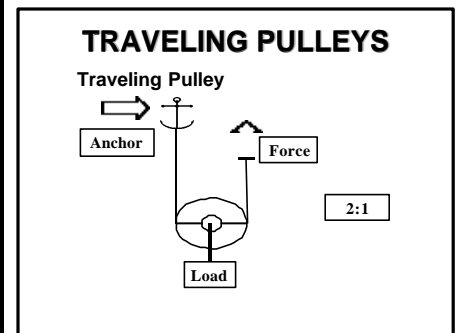
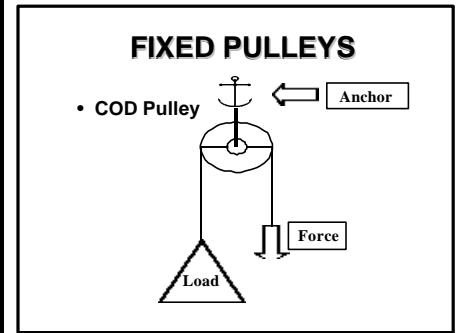

MODULE 4 - LIFTING AND RIGGING

A- FRAME GANTRY (continued)

- The object (Load) is attached to the apex of the Gantry using a short rigging strap, and a lowering control rope is connected opposite the mechanical advantage pulley system.
- As the gantry is tensioned and elevated, the load starts to rise. A hoist or come-along may also be used to initially suspend the load.
- The A-frame apex must be rotated to be centered over the load, but the angle between the ground and the A-frame should not be less than 45 degrees.
 - At this angle the initial force on the hauling rope system is about 25% greater than the load, assuming that the hauling anchors are placed at least 30 ft from the A-frame feet.
 - The force in each of the A-frame legs will be about equal to the load as the lifting begins.
 - As lifting begins, forces are generated in the A-Frame legs
 - The horizontal force tending to move the base of each of the A frame legs away from the load will be about 2/3 of the load.
 - There will also be a verticle load acting into the ground at the frame base that is about equal to this horizontal force.
 - These forces need to be resisted by the ground, and/or some type of restraint system.
- The dimensions and forces for two A-Frame systems, using 45 and 60 degree initial angles are shown in the adjacent slides and on the following page.

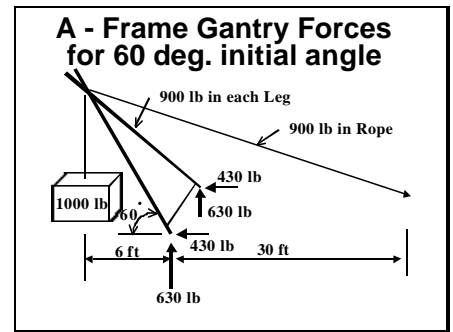
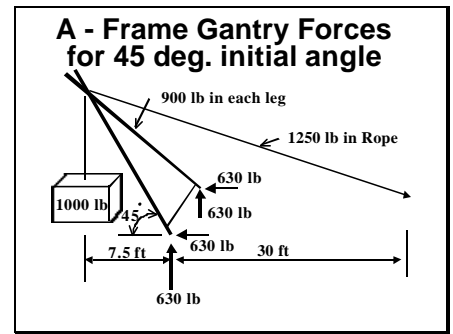

MODULE 4 - LIFTING AND RIGGING

DIAGRAM OF TIMBER A-FRAME

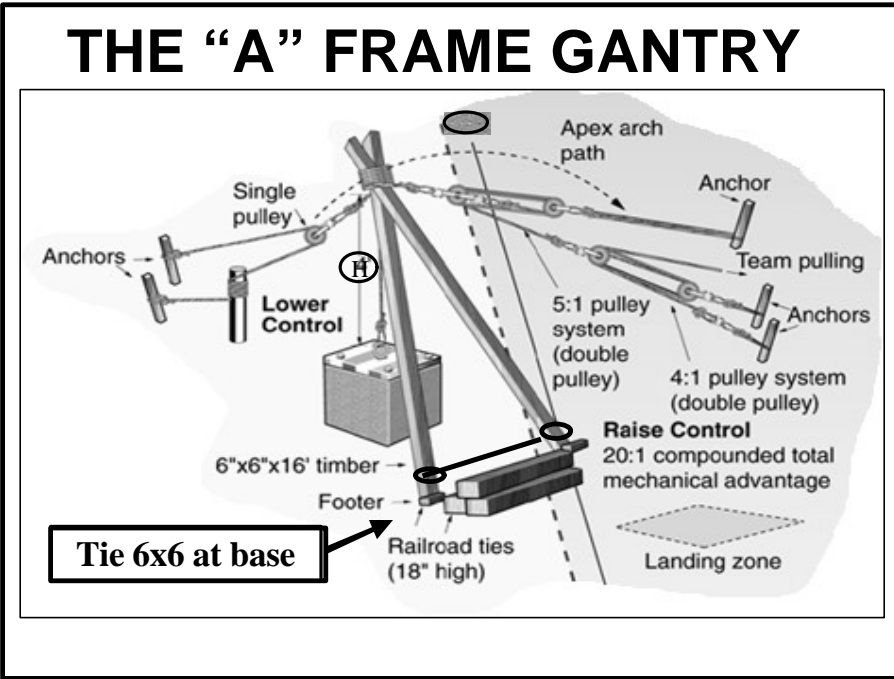
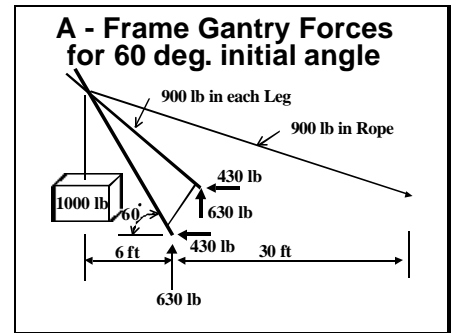
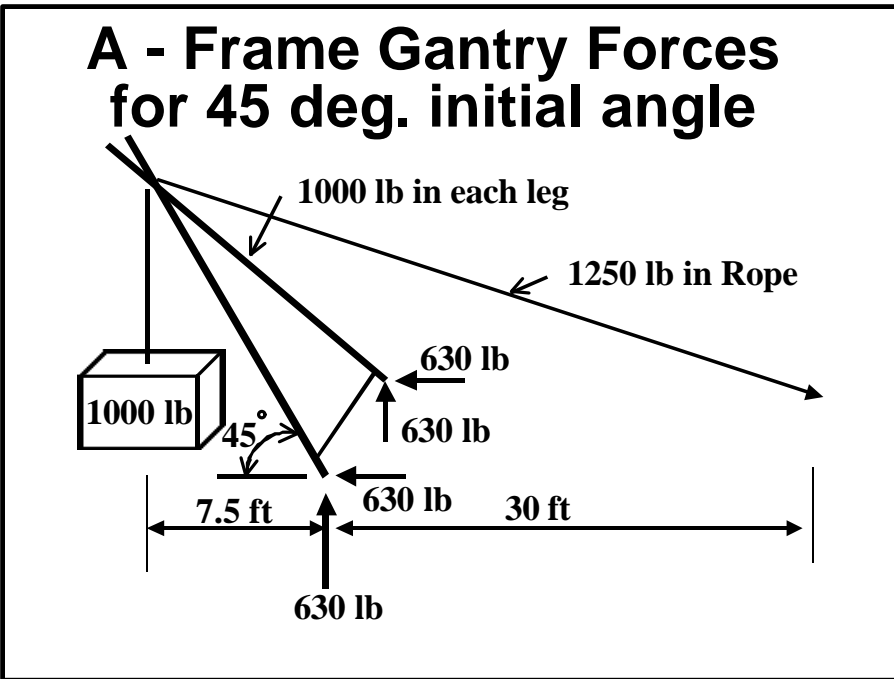

DIAGRAM OF A-FRAME FORCES at 45 degree angle
 (per 1000lb load. Suggested maximum Load = 4000lb)
 Loads for 60 degree shown in slide adjacent slide



MODULE 4 - LIFTING AND RIGGING

A-FRAME GANTRY (continued)

- In most cases it is necessary to provide a footing/baseplate for each leg of the A-frame.
 - In very firm ground, a shallow hole may provide enough resistance to the compression forces that are exerted when the A -frame legs rotate.
 - The forces at the edges of the 6x6 will dig into the ground and create their own bearing surfaces.
 - In softer ground, it may be necessary to use a pair of 12" square plywood gussets to spread the load, and neoprene pads will be helpful in providing shaped bearings for the edges of the 6x6 as it rotates.
 - On concrete paving surfaces, it will be necessary to carefully restrain the 6x6 from slipping, and provide for the rotating bearing.
 - In the Airshore Rescue Strut A-Frame system, a 12" square baseplate that provides for the bearing and rotating leg.
 - This baseplate must be properly restrained using rope, chain, or other mechanical anchors.
- As the gantry is arched over, the load elevates until the gantry is straight up and the object being lifted is directly beneath apex.
 - As the load moves past 90 degrees, the pulley system becomes useless, and the lowering ropes take over the controlled lowering of the load.

HIGH PRESSURE AIR BAGS

- Characteristics are:
 - Neoprene/butyl rubber — outer
 - Steel/Kevlar — reinforcement
 - Variety of sizes
 - Outer layer textured to reduce slippage
 - Capacity is calculated at 1" of lift
 - At maximum height, usable capacity typically is reduced to 50% of the rated capacity.

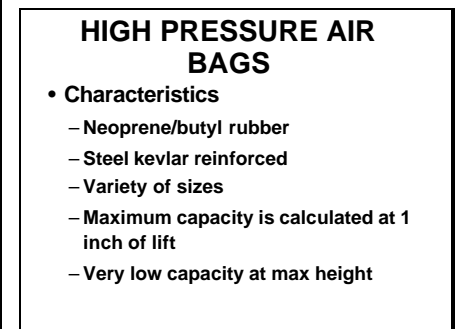
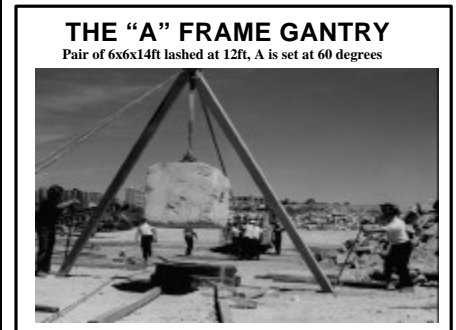

MODULE 4 - LIFTING AND RIGGING

HIGH PRESSURE AIR BAGS (continued)

- Application:
 - Maximum stack of two high (**bag centers must align**)
 - Lift capacity is that of the smaller bag
 - Lift height is increased
 - Ensure that the smallest bag has capacity for the lift
 - Place the large bag on the bottom
 - Keep air pressure in the larger bag less than in the smaller bag

- Bags in tandem:
 - Bags side-by-side or at two points on a load
 - Maximum working capacities added together
 - Consider lift height as well as load weight

- Working area:
 - Flat surface
 - Solid cribbing bed under bag
 - Establish safe zones
 - Pressurize bags slowly and watch for load shift
 - If load is uncontrolled, stop the lift and reevaluate
 - Use solid cribbing or wedges under the load to stabilize
 - See manufacturer's manual for additional information

- Calculating lifting capabilities:
 - Maximum working pressure of individual bag
 - Surface area contact (is smaller than bag dimensions)
 - Working pressure of bag under load when in use
 - Maximum working capacity is the maximum contact surface area of the bag (**always smaller than bag dimensions**) times the maximum working pressure.
 - As the air bag lifts and "pillows," surface contact is reduced and the lift capacity is decreased

EXAMPLE

- 10" x 10" air bag is 100 sq.in. in total area. The maximum working pressure is 118 PSI, and 100 sq.in. times 118 PSI = 11,800 lbs. of lift (5.9 tons) if full bag area was in surface contact. **From chart, actual capacity is 4.8 tons.**

- Check bag for **Identification Tag** that lists maximum pressure, load and lift height data.

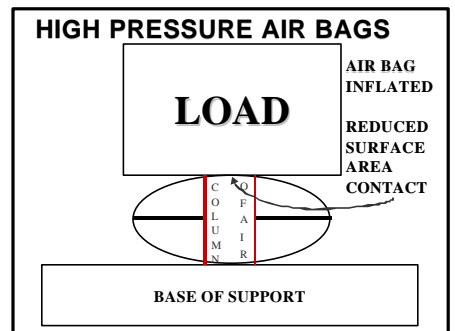
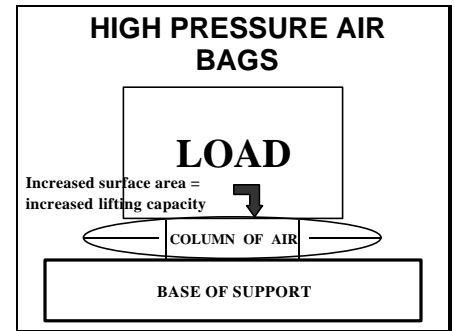

HIGH PRESSURE AIR BAGS			
Dimension	Capacity	Lift Ht.	Weight
6"x 6"	1.5 Tons	3"	2 lbs
6"x 12"	3.2	3.5	3
10"x 10"	4.8	5	4
15"x 15"	12.0	8	10
15"x 21"	17.0	9	13
20"x 20"	21.8	11	16
24"x 24"	31.8	13	22
28"x 28"	43.8	16	30
36"x 36"	73.4	20	48

HIGH PRESSURE AIR BAGS
I.D. Tag is right on Bag

MAXIFORCE KPI 12
 AIR LIFTING BAG SERIAL# 940492
 MAXIMUM LIFTING CAPACITY 12TONS 10845 KG
 MAXIMUM WORKING PRESSURE 118 PSI 8 BARS
 MAXIMUM LIFTING HEIGHT 8 IN. 208 MM
 MAXIMUM AIR CAPACITY 2.3 CU FT 65 LITERS
 PARATECK INCORPORATED FRANKFORT, IL. U.S.A.
 READ INSTRUCTIONS BEFORE OPERATING THIS EQUIPMENT

MODULE 4 - LIFTING AND RIGGING

MECHANICS OF LOAD STABILIZATION AND MOVEMENT

- Four functions that need to be addresses before any load is stabilized, lifted, or moved:
 - Center of gravity
 - Load Stability including Shims, Wedges & Cribbing
 - Estimating Load Weight
 - Lifting Functions including Critical Angle Considerations

CENTER OF GRAVITY

- **Center of gravity** is where any load's entire weight is concentrated.
- Loads will seek to have their center of gravity below the point of support.
- Moment of force (distance times weight) is created when the center of gravity moves around a fulcrum.
- Narrow base of support can rapidly become fulcrum (pivot point) for the load.
- The higher the center of gravity is located in the load, the wider and more stable the base of support needed to maintain the static equilibrium.
- A load with a relatively high estimated center of gravity and narrow base of support must be considered to be in a state of unstable equilibrium = moment of force of load's own weight (or external force) can cause the load to move into a state of equilibrium (i.e., fall over).
- Load rotation when the lifting point of the rigging is not directly above the center of gravity.

LIFTING OR MOVING A LOAD

FUNCTIONS TO BE ADDRESSED

- Center of gravity
- Load stability
 - wedges & cribbing
- Estimating Load weight
- Lifting Functions
 - critical angle

CENTER OF GRAVITY AND LOAD STABILITY

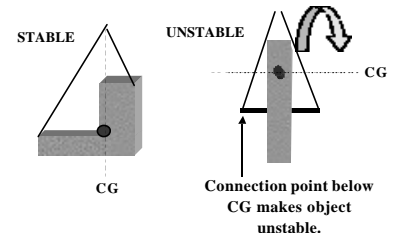

MODULE 4 - LIFTING AND RIGGING

LOAD STABILIZATION

- Make load attachments above center of gravity when possible.
- Place attachments above and on either side of the estimated position of center of gravity to control load.
 - Wind or shaking from an earthquake (external force) can move a load with high estimated center of gravity and narrow base of support.
- Widen and extend the load base of support when:
 - Distance from base of support to estimated center of gravity is greater than the width of base of the support. Loads showing any signs of rocking or swaying = unstable equilibrium state. Consider that center of gravity may change:
 - Ground shaking changing position of internal load such as machinery in structure
 - Base of support shifting

SHIMS / WEDGES / CRIBBING

- Characteristics
 - Douglas Fir or Southern Pine
 - Tends to crush slowly
 - Provides advance warning of failure
 - 500 pounds per sq. inch (psi) maximum load capacity
- Shims (wedge):
 - Stabilizing tools.
 - Incline plane (MA).
 - Take up void space.
- Wedge Set:
 - Snug up or tighten load.
 - Change of direction.

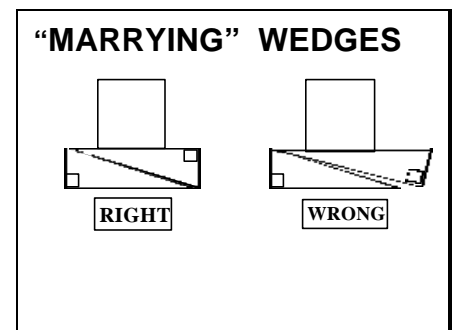
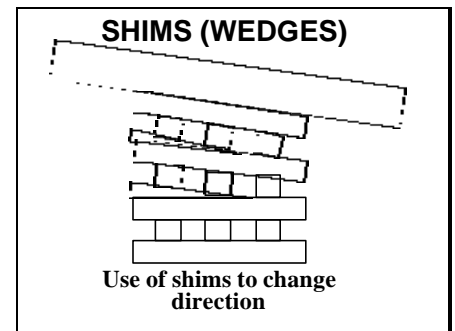

MODULE 4 - LIFTING AND RIGGING

■ **Cribbing Types:**

- Box (2 x 2 Crib) : four points of contact
- Crosstie (3 x 3 Crib) : 9 points of contact
- Solid : entire surface area contact

■ **Cribbing strength is determined by figuring the surface area at each point of contact and multiplying by the wood strength**

- 500 psi for Douglas Fir, but as low as 250 psi for softer wood..

■ **Example:**

- 4x4 box cribbing is really 3.5" X 3.5" = 12.25 X 500psi. = 6,125 lbs. per contact point. Call it 6000 lbs
 - Total for Box Crib = 4 x 6000 = 24,000
 - Total for 3 x 3 Crib = 9 x 6000 = 54000
- 6x6 box cribbing is really 5.5" X 5.5" = 30.25 X 500 lbs. = 15,125 lbs. per contact point. Call it 15,000 lbs
 - Total for Box Crib = 60,000 lbs
 - Total for Crib 3 x 3 = 135,000 lbs

■ **Height of cribbing when used to stabilize loads to be moved should be limited to two times the width.**

- Support the load on the contact points (load to ground).
- When using cribbing to support collapsed structures the height may be increased to three times the width.

■ **See Module 2a for additional information regarding Cribbing including:**

- Overlap at corners
- Recommended heights when using more than one crib to share the load.

ESTIMATING LOAD WEIGHTS

- **Size formula for solid objects = L x W x H**
- **For pipe = 3 Diameter x L x thickness**
- **Weight for material in pounds per cubic foot (pcf)**
 - Reinforced concrete = 150 pcf
 - Steel use 490 pcf
 - Earth use 100 pcf
 - Wood use 40 pcf

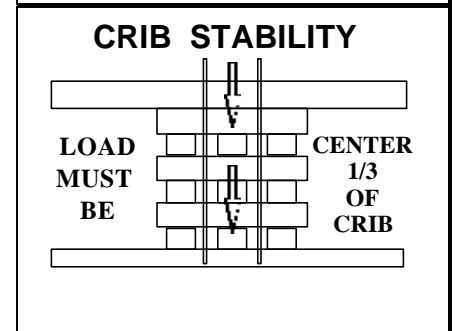
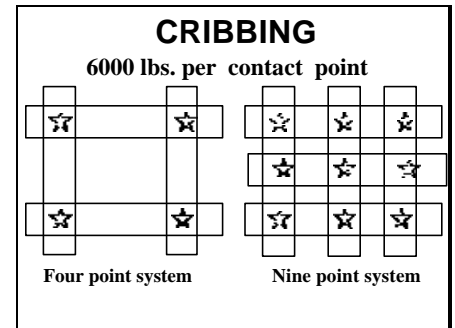

CALCULATING THE WEIGHTS OF COMMON MATERIALS

LENGTH x WIDTH x HEIGHT = CUBIC FT

- Steel 490 lbs. per cubic foot (pcf)
- Concrete 150 lbs. per cubic foot
- Earth 100 lbs. per cubic foot

CALCULATING THE WEIGHTS OF COMMON MATERIALS

LENGTH x WIDTH x HEIGHT x WEIGHT

20' X 4' X 2' = 160cf x 150pcf = 24,000 lbs.

MODULE 4 - LIFTING AND RIGGING

LIFTING FUNCTIONS

- Attachments:
 - Chains
 - Cables
 - Ropes
 - Webbing
- BASIC GUIDELINES: Locations of attachment should be:
 - Directly over/in alignment with the load's center of gravity (CG).
 - Above the load's CG.
- Rigid objects should be supported by at least two attachments along with balancing support attachments.
 - Weight on the carrying attachments is more important than the total weight of the load.
 - Angles of attachments influence hauling system effectiveness.
- When center of gravity of load lines up over the fulcrum or pivot point, balance point has been reached, and load is at static equilibrium.
- When making a vertical lift, attachments should be above center of gravity when possible.
 - This will keep load from rotating, and under control.

CRITICAL ANGLE CONSIDERATIONS

- The angle of a rigging strap/ cable attachment in relation to the lifting point greatly effects the vertical and horizontal forces placed on the anchor attachments as well as the forces in the strap/cable.
 - These forces are easily calculated, based on the properties of the triangle that is created.
- A circle can be divided into three 120 degree sections.
 - If the included angle of the rope system is equal to 120 degrees, the force in the rope and it's attachment is equal to the supported load.
 - If the angle becomes greater by pulling the load line tighter, a greater force is placed on the rope and the anchors.
 - If the included angle is less, the force in the rope is less.
 - In lifting systems the angle should be as small as possible

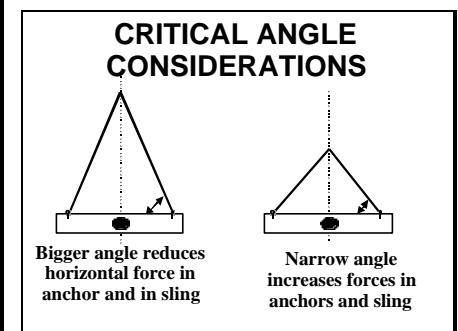
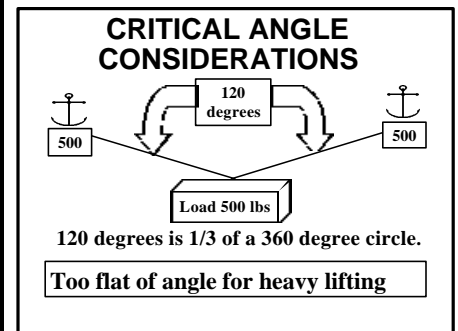

MODULE 4 - LIFTING AND RIGGING

- Applying this concept to rigging can be done by inverting the triangle.
 - The higher the point of attachment is over the objects CG the lesser the forces on the sling and it's attachments.
 - The flatter the angle, the greater the forces.
 - Keep this in mind when you begin any lifting operation.
 - In some cases lifting a fairly light object with a flat lifting angle will create forces substantial enough to break the sling and/or blow-out the anchor points.

ANCHOR SYSTEMS AND RIGGING DEVICES

INTRODUCTION

- The purpose of this section is to provide information about safe and practical methods of anchoring to concrete when some other method (such as cable loops or chokers) is not available.
- Not all of the methods discussed may have useful application in US&R work.
 - The special equipment required for undercut anchors and the sensitivity of epoxy anchors to vibration and heat, make both of little value in critical US&R situations.
- All of the available methods are presented in order to give the student a more complete understanding of anchors, and then to focus on those that are most useful.

TYPES OF ANCHORS:

Most of these anchors require the drilling and cleaning of holes in concrete of the proper size and depth.

- Available types:
 - Undercut Anchor Bolts
 - Expansion Bolts
 - Expansion Shields
 - Epoxy Anchors
 - Concrete Screws
 - Through Bolts

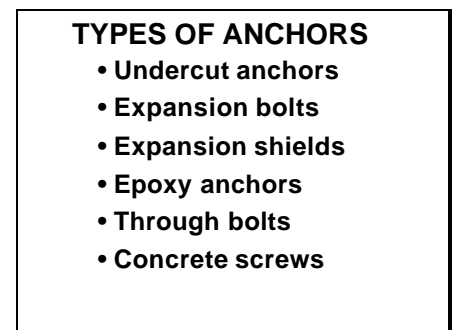
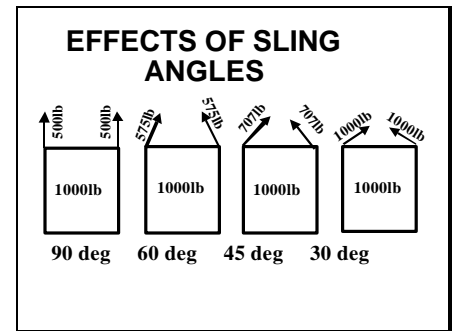

MODULE 4 - LIFTING AND RIGGING

Undercut Anchor Bolts

- Relatively complicated devices that require the cutting of a straight hole in the concrete and then inserting a special bit that enlarges the hole near its bottom.
- The undercut anchor bolt is then inserted and during the tightening process, prongs extend out from the body of the bolt that engage and bear on the surface of the enlarged hole.
- This produces a very positive anchor, since it does not have to depend on friction between the bolt and the hole as in the case of the other anchors presented here.
- The system requires the use of the special drill bit that undercuts the hole, and, therefore, would not be useful in most emergency situations.

Expansion Bolts

- Are torque controlled anchors that come in two types; Wedge Anchors and Sleeve Anchors. They both have an undercut shaft that is inserted into the hole and the wedge or sleeve device that expands as a cone at the bottom of the shaft is pulled through it when the fastener is tightened.
- Wedge Anchors have higher tension strength than sleeve anchors of the same size. However the sleeve anchor is the only anchor bolt (other than the through bolt) that can be safely be used in hollow concrete block.
- Correct hole size (not too large) is very important since the wedge or sleeve must develop great friction against the sides of the hole.
- Most of these anchors will develop more friction as they are loaded in tension, since more expansion occurs as the pull on the shaft causes the cone to spread the wedges or sleeve with greater force against the side of the hole.
- Applying a setting torque with a calibrated wrench is essential to the reliable performance of this type of anchor, since doing so actually tests the installation.

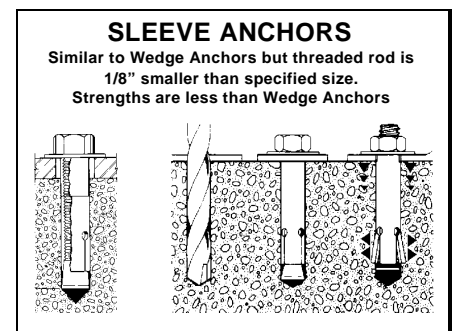
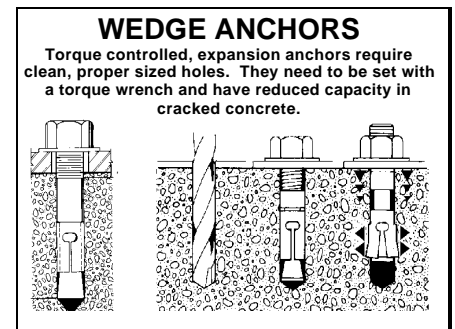
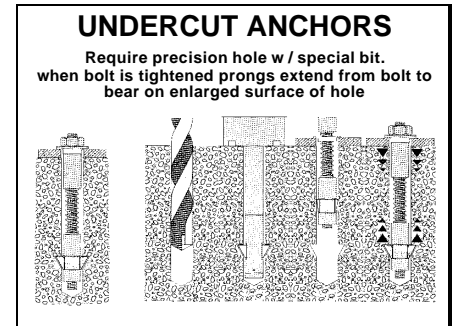

MODULE 4 - LIFTING AND RIGGING

Expansion Bolts (continued)

- The proper failure mode for this type of anchor is either pull-through (where the conical part of the shaft pulls through the sleeve or wedge) or pull-out of a concrete cone.
 - The diameter of concrete cone that can be pulled is usually more than two times the depth of the embedment of the anchor, however, this assumes un-cracked concrete.
- Anchors of this type should not be used in badly cracked concrete.
- Expansion anchors may be used to anchor raker shores and in tieback systems, provided that the concrete into which they are set is relatively crack free.

Expansion Shields

- Are displacement controlled anchors that expand by means of driving the steel shield over a cone using a hammer and special driving tool that fits to the shoulder of the shield.
- These fasteners are not capable of further expansion under load and cannot be torque wrench tightened and tested.
 - They are vulnerable to oversized holes and are not recommended for critical search and rescue operations.
- Expansion shields are reliable if holes are cleaned and of proper size and could be successfully used for lifting out small sections of concrete (such as wall or floor access openings).

Epoxy Anchors

- Usually consist of threaded rods that are set in cleaned, drilled holes that have been previously filled with a properly mixed epoxy adhesive.
- These anchors induce no expansion forces in the concrete, and therefore, can be installed at closer spacing.
- Epoxy anchors are not as sensitive to strength reduction from cracked concrete, but require time to develop strength.

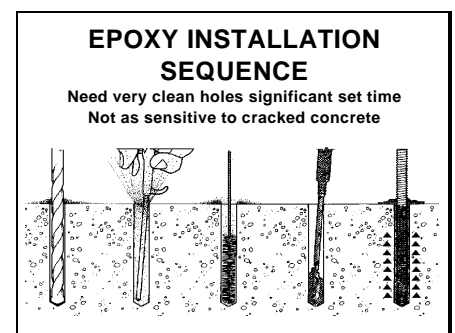
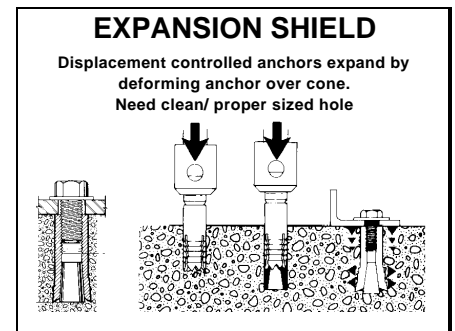

MODULE 4 - LIFTING AND RIGGING

Epoxy Anchors (continued)

- The most reliable method to insert the epoxy into the hole is to use a caulking gun type device that is designed to be used with a coaxial cartridge.
- The cartridge contains the epoxy resin in one cylinder and the setting compound (accelerator) in the other cylinder.
 - This method can produce reliable anchors in masonry as well as concrete and strength and reliability are enhanced by using depths greater than twelve times the anchor diameter.
- Epoxy anchors have two limitations that make them of limited use for US&R.
 - First, if the installed anchor is significantly vibrated or otherwise moved prior to the epoxy being fully set, the anchor may have little strength.
 - Also epoxy installations lose strength at temperatures over 80 deg F, and have only about 25% of their strength at 160 deg.

Concrete Screws

- These anchors have relatively low strength (100 to 600 lbs.) fasteners, and have 3/16" and 1/4" diameters.
- They are driven into a pre-drilled hole and the installation requires the use of the manufactures drill bit and setting tool.
- They can be installed in less than one minute and placed as close as one inch from the edge of the concrete.

Through Bolts

- In some cases when both sides of a concrete slab are accessible, a standard machine bolt or piece of threaded rod can be extended completely through the concrete.
 - If a large washer and bolt head (or double nuts) bears against the far side of the slab, a simple, reliable anchor is created.

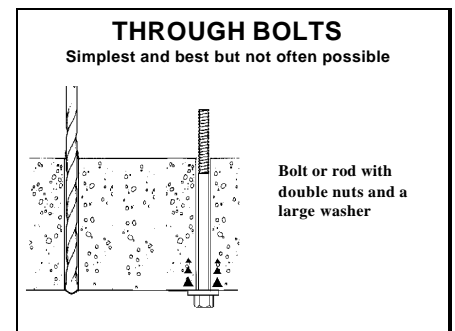
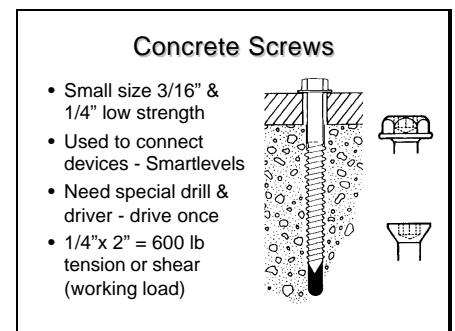
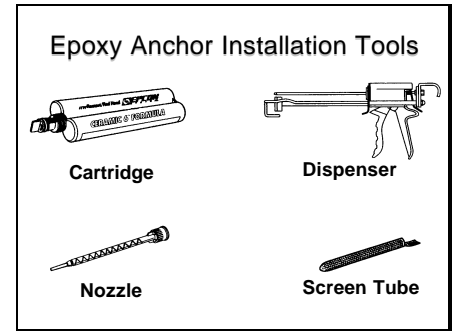

MODULE 4 - LIFTING AND RIGGING

- The allowable tension value for a through bolt would be the same as for an expansion bolt of the same size with embedment the same as the thickness of the slab that the bolt projects through.
- Through bolts require access to both sides of the concrete piece in question, and, therefore may not have much application in lifting or holding concrete in debris piles.
- Through bolts are very useful when anchoring to URM walls, and could be very useful in tieback systems where concrete or URM walls are involved.

ANCHOR APPLICATIONS

- Anchor Spacing & Edge Distance
 - Minimum spacing between anchors: 12 times the diameter of the anchor
 - Minimum distance to nearest concrete edge: 6 times the diameter of the anchor
 - Minimum anchor depth in concrete: 6 times the diameter of the anchor
 - Anchor depth should be increased to 9 times the diameter of the anchor, since at ultimate load a more gradual failure will occur.
- One can increase tension values especially in lower strength concrete (2000 PSI) by increasing embedment and spacing to as much as double the minimum listed strength values.
- Cracks in concrete near expansion bolts or shields can significantly reduce their strength.
 - Cracks do not significantly reduce the strength of Epoxy and Through Bolt anchors.

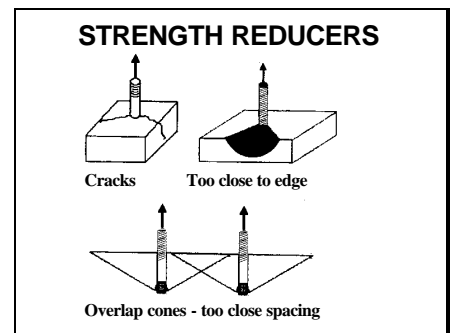
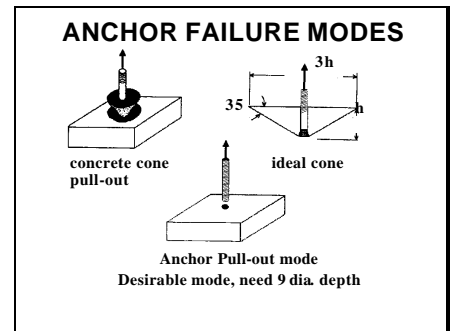
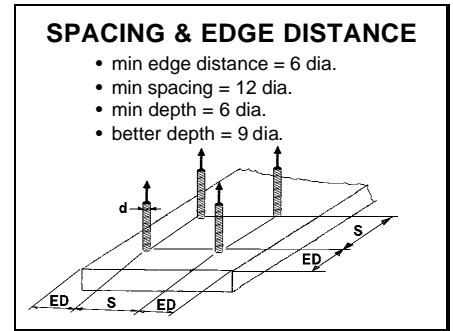

MODULE 4 - LIFTING AND RIGGING

ULTIMATE LOAD VS WORKING LOAD

- The strength of these anchors has been determined by laboratory testing under “ideal” conditions, and is published as the Ultimate Strength.
 - If only the “strength” is listed without the word “Ultimate” one should assume that the value given is the Ultimate Strength and that the safe working load is about one fourth as much.
- The *Allowable Working Load* (sometimes called Safe Working Load or Working Load) should be listed as not greater than one fourth the *ultimate strength*.
- The values given for most anchors are based on the ultimate crushing strength of the concrete into which they are inserted.
 - F'c=3000 PSI) means that a 6” diameter x 12” high cylinder made from the concrete will crush at 3000psi when tested 28 days after it was cast.
 - Most sound concrete can be assumed to have an *ultimate strength* of 3000 PSI.
 - Test it with a heavy blow from a framing hammer. It should ring and not be noticeably damaged, as long as its not hit on a corner.

Ultimate load vs Working load
(called different things by
different Anchor Manufacturers)

- working load = allowable working load
- working load = safe working load
- working load = 1/4 ultimate load

INSTALLATION OF ANCHORS

- Drilled holes should be the proper size and depth. Dull bits produce oversized holes which can lead to premature pull-out.
- A metal detector should be used to locate existing rebar, so that it can be avoided.
 - Hitting rebar with the bit will cause oversized holes, and a dull bit which will continue to produce oversized holes.
- Holes need to be cleaned of all loose material (especially for epoxy anchors).
 - Its best to use a brush plus compressed air to clean holes. If a brush is not available, use a piece of small rebar to dislodge material plus a can of compressed air will usually clean a hole.
 - The equipment cache should include some cans of compressed air if a compressor is not available.
 - A 12” length of 3/8 inch copper pipe is useful to apply the air to the bottom of the hole.

INSTALLATION

- Hole size very important
- Use metal detector to avoid rebar
- Need to clean holes, especially for epoxy
- Torque all expansion bolts = test
- Epoxy anchors require special care, set time, and no vibration
- Concrete screws require drill bit & driver

MODULE 4 - LIFTING AND RIGGING

INSTALLATION OF ANCHORS (continued)

- Expansion bolts need to be tightened with a calibrated torque wrench as previously discussed.
 - This tests and “preloads” the anchor, giving one reasonable confidence in the installation.
 - See table on following page for Anchor strength and required torque values.

- Expansion shields should be inserted in clean holes of proper size in order for enough friction to develop between the expanded shield bottom and the hole size.
 - These anchors are reliable if installed correctly, using the manufacturer’s setting tool.
 - They may only be tested by applying a tension load directly to the anchor.

- Epoxy anchors should be inserted into previously cleaned holes after the epoxy has filled the hole about 3/4 full.
 - The epoxy should be placed using a coaxial cartridge dispenser with a long tube that reaches to the bottom of the hole.
 - Fill the hole from the bottom up, in order to minimize air pockets.
 - Insert the threaded rod with a twisting motion and work out all the bubbles.
 - The fastest setting epoxies require at least one hour at 70 degrees F (20° C) to develop working load.
 - This time must be increased to 12 hours at 40 degrees F (5° C).
 - Normal setting epoxy requires a minimum of 24 hours at 60° F (15° C) and above.

- Concrete screws need to be installed using the manufacturers provided drill bit and setting tool.
 - Holes do not need to be cleaned, however the screws can be driven into the holes only once, since the threads cut their way into the concrete.

INSTALLATION

- Hole size very important
- Use metal detector to avoid rebar
- Need to clean holes, especially for epoxy
- Torque all expansion bolts = test
- Epoxy anchors require special care, set time, and no vibration
- Concrete screws require drill bit & driver

MODULE 4 - LIFTING AND RIGGING

ALLOWABLE WORKING LOADS for WEDGE ANCHORS

WEDGE ANCHORS

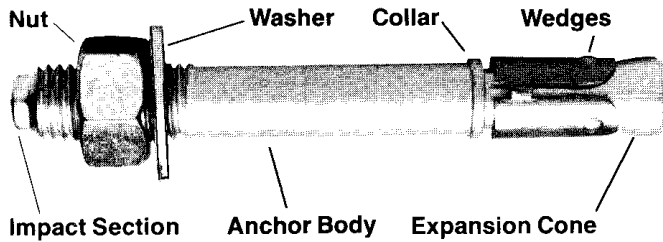

Kwik Bolt II or Trubolt Allowable Tensile Loads (lbs)

Dia- meter	Embedment	Required Torque (ft-lb)	$f'_c =$ 2000 psi	$f'_c =$ 3000 psi
3/8"	1 5/8"	20	530	605
	2 1/2"	use 25	1130	1210
	4 1/4"	25	1200	1230
1/2"	2 1/4"	40	870	970
	3 1/2"	use 50	1750	2000
	6"	65	1970	2170
5/8"	2 3/4"	85	1430	1690
	4"	use 100	2170	2670
	7"	110	3000	3270
3/4"	3 1/4"	150	1850	2180
	4 3/4"	use 225	2750	3630
	8"	235	3750	4630
1"	4 1/2"	250	2930	3650
	6"	use 350	4000	5310
	9"	450	6070	7070

Allowable Shear Loads (lbs)

Dia- meter	Embedment	$f'_c =$ 2000 psi	$f'_c =$ 3000 psi
3/8"	1 5/8"	930	970
	≥ 2 1/2" *	1100	1100
1/2"	2 1/4"	1810	1840
	≥ 3 1/2" *	1840	1840
5/8"	2 3/4"	2880	2880
	≥ 4" **	3140	3140
3/4"	3 1/4"	3880	3880
	≥ 4 3/4" ***	4220	4220
1"	4 1/2"	6620	7120
	≥ 6"	8620	8620

INCREASE TEN. & SHEAR VALUES 1.33x
 FOR WIND & EARTHQUAKE LOADING

$$\text{TEN} + \text{SHEAR}: (P/P_{\text{allow}})^{5/3} + (V/V_{\text{allow}})^{5/3} \leq 1$$

MODULE 4 - LIFTING AND RIGGING

ALLOWABLE WORKING LOADS for EPOXY ANCHORS

EPOXY ANCHORS

Allowable Loads - Threaded Rod Anchors

Allowable Tensile Loads (lbs)							
Stud Dia	Drill Bit Dia	Min Embed Depth	Spa-cing	Edge Dist	Avg ult 2500 psi	Based on Bond Strength	
						fc = 2000	fc=2500
3/8"	1/2"	3 1/2"	4 1/2"	2 5/8"	8888	1985	2220
1/2"	5/8"	4 1/4"	6"	3 1/4"	10384	2320	2595
5/8"	3/4"	5"	7 1/2"	3 3/4"	17512	3915	4375
3/4"	7/8"	6 3/4"	9"	5"	27896	6235	6970
7/8"	1"	7 1/2"	10 1/2"	5 5/8"	32032	7160	8005
1"	1 1/8"	8 1/4"	12"	6 1/4"	41813	9350	10450

Allowable Shear Loads (lbs)				
Avg Ult 2500 psi	Based on Bond Strength			Based on Steel Strength
	fc = 2000	fc = 2500	fc = 3000	A 307
4096	910	1020	1750	1040
9664	2160	2415	3375	1870
13952	3115	3485	2965	2940
25920	5795	6480	4380	4250
24970	5580	6240	7275	6000
28746	6425	7185	7275	7820

Allowable tensile loads for ASTM A615 Gr 60 Reinforcing Bar

Rebar Dia.	Drill Bit Dia.	Minimum Embedment Depth	Concrete Compression Strength	
			fc = 2500	fc = 4500
No. 4	5/8"	4 1/4"	3055	3565
No. 6	7/8"	6 3/4"	7850	9070
No. 8	1 1/8"	8 1/4"	9065	10240

Minimum spacing = 12 bar diameters
 Min. edge distance = 6 bar diameters

MODULE 4 - LIFTING AND RIGGING

LIFTING DEVICES

Cast Steel Hoist Rings

- Are devices that can be bolted to concrete using, preferably, an expansion bolt or through bolt.
- Since the ring's loop pivots 180 degrees and the ring's base swivels 360 degrees, the load will always be applied directly through the bolt into the concrete.
 - There is also no danger of the swiveling ring applying a de-torquing twist to the properly tightened, expansion anchor.
- These rings are available in sizes from 5/16" to 3". The 1/2" size is suggested as a minimum size, and it has a 2500 lb allowable working load which is greater than the 2000 lb of a 1/2" expansion anchor with 6" embedment.
 - The 1/2" Hoist Rings and Expansion Anchors have been included in the FEMA 1999 US&R Cache List
- For larger loads, it is recommended that the 3/4" size be used. It has a 5000 lb allowable working load. A 3/4 expansion bolt with 8" embedment has 4500 allowable working load.
- 1" hoist rings are available that have 10,000 lb allowable working load, but the 1" expansion bolt has only 7000 lb allowable working load and it requires the use of a torque wrench that will produce 400 ft. lbs of torque.

Steel Angles

- May be fabricated to be used with expansion bolts and /or through bolts, however, if not sized properly will cause the failure of the lifting system.
- To be useful an angle must be of sufficient thickness and length. A minimum of two bolts must be used with a single angle in order to assure that it will not spin and de-torque the expansion bolt.
- The angle must be long enough to allow for the 12 diameter spacing of the expansion anchors.
- Due to the prying action of the vertical leg of the angle against the expansion anchor it takes two expansion bolts to produce the same allowable working load as one bolt when used with the hoist ring.
- It is strongly recommended that this type of angle be used only if a hoist ring is not available.

LIFTING DEVICES

- Steel Swivel Hoist Rings
- Eye Nuts
- Steel Angles

Used when a better way of connecting to concrete is not available. (Sling, strap, or wire rope choker is not practical).

STEEL SWIVEL HOIST RINGS

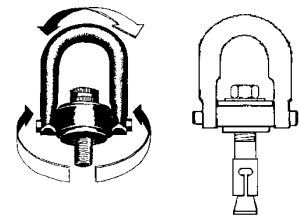

Steel Swivel Hoist Rings

- Pivot 180 deg & swivel 360 deg
- Usually are proof load tested
- Use with wedge anchor
 - discard machine bolt
 - torque required for wedge anchor is greater than torque listed for Hoist Ring but works fine for better quality Hoist Ring.
 - Don't buy Hoist Rings w/o Testing Them

EYE NUTS

- Attach over nut of installed wedge anchor
- Load in tension only (within 15 deg.)
- Use 3/8", 1/2", or 3/4"
- Capacity determined by anchor
- Tightened eye to nut
- 1/2" in FEMA 1999 Cache

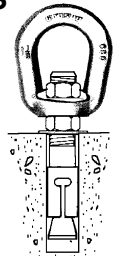

STEEL ANGLES

- Must be engineered
- Need minimum of two anchor bolts
- Use only if other methods not available

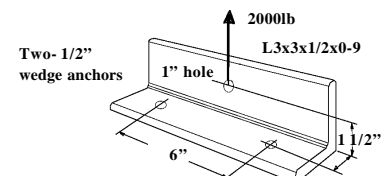

MODULE 4 - LIFTING AND RIGGING

RIGGING

SLINGS

■ Commonly used material for the manufacture of slings

- Wire rope
- Chain
- Synthetic Fibers

Rigging Definition: A length of rope / chain / webbing attached to a load to and/or an anchor for the purpose of stabilizing, lifting, pulling, or moving objects.

■ Wire Rope

- Very strong – suited for US&R environment
- Strength depends on size, grade, and core
- Resistant to abrasion and crushing
- Must keep from bending or kinking
- Sharp bends and edges can cause damage

■ Wire rope components

- Core
- Strand
- Wire
- Center

■ Wire rope safety factor

- Wire Rope Slings, Etc = 5 to 1
- Lifts w/ Personnel = 10 to 1
- Elevators = 20 to 1
- Mobile Crane = 3 to 1 for standing ropes
- Slings have greater factor of safety than for wire rope used on cranes due to likelihood of rough usage & wear

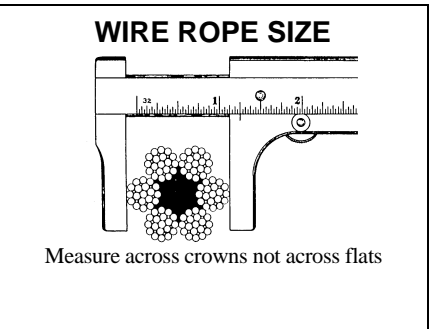
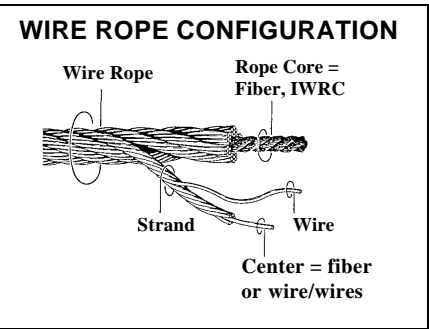

WIRE STRAND CONFIGURATIONS

The diagram shows four different wire strand configurations: Ordinary (6 wires in a circle), Filler (6 wires in a circle with a central filler wire), Seale (6 wires in a circle with a central filler wire and a different arrangement), and Warrington (6 wires in a circle with a central filler wire and a different arrangement).

Classification	No of Strands	Wires per Strand
6 x 7	6	3 to 14
6 x 19	6	16 to 26
6 x 37	6	27 to 49
8 x 19	6	15 to 26

WIRE ROPE SAFETY FACTORS

- Wire rope slings = 5 to 1
- Lifts w/ personnel = 10 to 1
- Elevators = 20 to 1
- Mobile Crane = 3 to 1 for standing ropes and 3.5 to 1 for running ropes
- Slings have greater factor of safety than wire ropes used on cranes due to likelihood of rough usage and wear

MODULE 4 - LIFTING AND RIGGING

SLINGS (continued)

- Wire Rope Inspection should be done on a regular basis
 - Need to check for conditions in adjacent slide
 - The following are wire rope discard conditions
 - Kinks
 - Bird cage
 - Core protrusions

- Wire rope fittings and terminations are available in many designs
 - Flemish eye
 - Most reliable and efficient termination. Must be done in a shop, and it does not reduce load capacity.
 - Fold back eye
 - Unreliable, do not use it.
 - Wedge socket
 - If properly manufactured and installed, will only reduce capacity by 10%
 - Cable clips
 - During past US&R incidents it has been necessary to construct cable terminations using these clips.
 - All rescue personnel should become familiar with how to position and tighten these very useful devices.
 - Reduce capacity by 20%

WIRE ROPE INSPECTION

- Should be done on regular basis
- Check for:
 - broken wires - depends on location
 - crushed strands
 - kinks, bird caging, & protruding core
 - stretch, diameter reduction
 - abrasion and corrosion
 - fatigue and electric arc

WIRE ROPE - DISCARD CONDITIONS

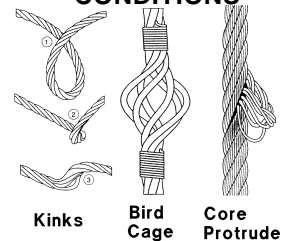

WIRE ROPE - DISCARD CONDITIONS

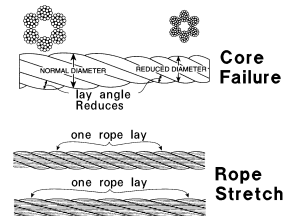

WIRE ROPE TERMINATIONS

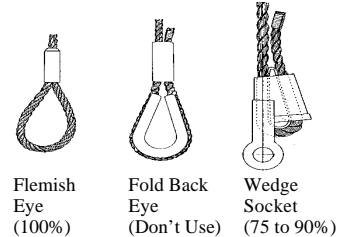

CABLE CLIPS - 80% EFFICIENT

- Clips are installed in succession and torqued per manufacturers specifications.
- Examples show loop end w/ & w/o thimble.
 - cable is flattened w/o thimble

MODULE 4 - LIFTING AND RIGGING

Chain and Chain Slings

- Limited use due to weight.
- Links can break without warning
- Requires padding between chain and load to create better gripping surface.
- Should not be exposed to cold temperatures for long periods of time.
- Avoid kinking and twisting while under stress.
- Load must be seated in the hook.
- Avoid sudden jerks in lifting / lowering the load.
- Use padding (planks, heavy fabric) around sharp corners on the load to protect links from being cut.
- Cannot use for overhead lifting unless tagged by manufacturer.

■ **Synthetic slings:**

- Tends to mold around the load adding additional holding power.
- Do not rust and are non-sparking.
- Are light weight making it easier and safer to rig, and carry on rubble pile
- Have no sharp edges thereby reducing injury potential.
- Are more elastic than chain or wire rope and can absorb shock loading better.
- Are not effected by moisture and are resistant to many chemicals.
- Are very susceptible to abrasion and catastrophic failure, especially in the collapse structure environment.

CHAIN SLINGS

- **Should have I.D. mark**
- **Avoid use where possible**
 - failure of single link = Failure if sling
- **Chain usually gives no warning of failure**
- **Chain is better for some uses**
 - takes rough handling
 - resistant to abrasion
 - no kinks
 - resistant to corrosion

CHAIN SLING IDENTIFICATION

I.D. Tag

Most common markings for alloy hoisting chain are: A , T , 80, or 800

CHAIN SLING PROBLEMS

Chain Stretch

Twisted Links

Gouged Links

SYNTHETIC WEB SLINGS

Triangle & Choker

Double Eye

Reverse Eye

Endless Loop

Return Eye

SYNTHETIC SLING TYPES

- **Nylon**
 - general purpose, unaffected by grease & oil, many chemicals except acids.
 - Loose 15% strength when wet
- **Polyester**
 - unaffected by most chemicals including mild acid and water. Disintegrate in sulfuric acid
- **Aramid, Kevlar, Dacron, Nomex**
 - resistant to most weak chemicals
- **High Density Polyethylene**
 - Resistant to most chemicals

MODULE 4 - LIFTING AND RIGGING

BASIC SLING ARRANGEMENTS

■ Single vertical / horizontal hitches:

- Supports load with single leg of rope / chain / webbing.
- Full load carried by a single leg (one straight piece of chain / rope / webbing).
- Should not be used when:
 - Load is hard to balance.
 - Center of gravity hard to establish.
 - Loads are loose.
 - Load extend past the point of attachment.

■ Basket hitches:

- Supports load by attaching one end of the sling to a hook.
- Sling wrapped around the load.
- Sling returns to the other end to attach to the same hook as the other side of the sling.
- Presents problems related to keeping the load balanced or stabilized.

■ Double basket hitches:

- More stable than single basket hitch.
- Uses 2 single slings wrapped at separate locations on the load in the same manner .
- Allows for the locating of the center attachment hook over the estimated center of gravity.
- Permits the wrapping of the slings to either side of the center of gravity.
- Can use a "double wrap" basket hitch which makes contact all the way around the load surface for increased securing of loads (i.e., good for cylindrical loads).

■ Single choker hitches:

- Loop a strap / rope around the load.
- Pass 1 eye through shackle attached to the other eye.
- Pass the eye over the hook.
- Sling should be wrapped around the load.
- Sling is secured back onto itself.
- Potential of having stability problems.
- Creates a vise-like grip on load.

SYNTHETIC SLINGS

- Must include manufacturer's sewn on tag
 - gives fiber type and Safe Working Load
- Provided with protective cover - seamless
- Use corner protection
- Need careful inspection
- Do stretch - up to 10% ; Polyethylene = 1%
- Very light weight and easy to use
- Minimize twisting & spinning during lifting

SLING ARRANGEMENTS

- Double choker hitch
- Choker hitch
- Bridle hitch
- Basket hitch
- Double basket hitch
- Single vertical hitch

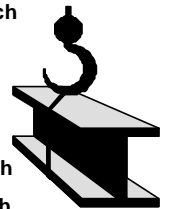

SLING ARRANGEMENTS & SAFE WORKING LOADS

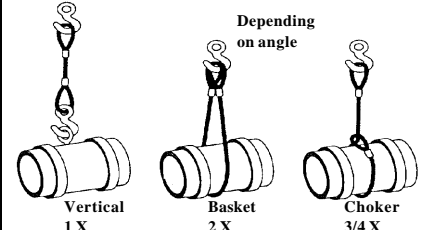

SINGLE BASKET HITCH

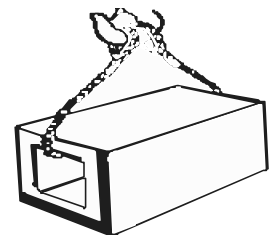

MODULE 4 - LIFTING AND RIGGING

BASIC SLING ARRANGEMENTS (continued)

■ Double choker hitches:

- Has two single slings spread apart around the load.
- Does not make full contact with the load surface.
- Can be double wrapped to help control / hold the load.
- Double choker with 2-points of wrap around the load provides better lifting / pulling / stabilizing / moving than single choker.
- When using straps in pairs, hooks should be arranged on the straps so that they will pull from the opposite sides = better gripping action.
- Creates a vise-like grip on load.

■ Bridle hitches:

- Uses 2 / 3 / 4 single slings -- each sling is called a "LEG."
- Slings secured to a single point this is usually in line between the center of gravity and the anchor (lifting point).
- Can provide very stable lifting, stabilizing, moving, pulling due to distribution of load onto the multiple slings.
- Sling lengths must provide for even distribution of the load.

- Basic guideline for sling formations - make sure slings protected at all actual or potential sharp corners in contact with loads.

DOUBLE CHOKER HITCH

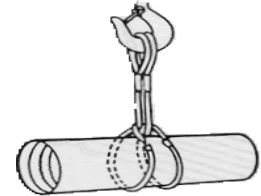

MODULE 4 - LIFTING AND RIGGING

TIGHTENERS

- Wire rope tighteners have been required during many US&R incidents.
 - They may be used for lifting light loads as well as tightening cable tiebacks and other rigging.
 - Care needs to be taken to not overload them. **DO NOT ADD CHEATER BARS TO THE HANDLES**

- They are available in several configurations, and are included in the FEMA US&R Cache.

- Cable winch
 - The length of the handle and the strength of one person provides the Overload Limit. **DO NOT ADD TO LENGTH OF HANDLE.**
 - Take care in re-winding the cable, it can foul.
 - These devices are 2 to 3 feet long, therefore their use may be limited in confined spaces.

- Load binder (most common with chain use)
 - Use ratchet type for reliability, and must wire tie handle for safety.
 - They have 50 to 1 ratchet action, but only have 8 inch take-up.

- Chain hoist
 - Can lift up to 6 tons with 100lb pull. **DO NOT EXTEND HANDLES OR OVERPULL USING MORE THAN ONE PERSON.**
 - These tighteners have large take-up (up to 10 feet), and some only require only 12 inch clearance.

- Turnbuckles
 - Commonly used tightening device, and are in the US&R Cache
 - Can be used to do final tightening of tiebacks, and liberate Cable Winch to do other jobs.
 - The maximum take-up can vary from 8" to 24", depending on what type is purchased.
 - They may be difficult to tighten at high loads, so keep the WD-40 handy.
 - HOOK ends are only 2/3 as strong as EYE or JAW ends

**PORTABLE CABLE WINCH
(Come a long)**

Safety Issues
 F.S. may be from 1.5 to 3
 Inspect carefully
 Do not use Handle Extender

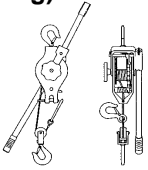

- 0.5 to 3 Ton Capacity
- Weigh 7 to 35 pounds
- Large Take-up

**LOAD BINDERS
(use ratchet type)**

Weight = 14 lb

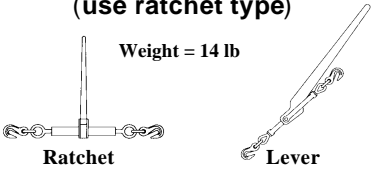

Ratchet Lever

- 26 to 46 Ton Ultimate Capacity
- 3.3 to 6.5 Ton Working Load
- Limited to 8" Take-up

**CHAIN HOISTS, FALL &
RATCHET LEVER**

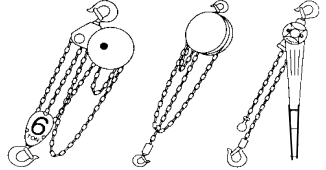

Up to 6 Ton Up to 5 Ton Up to 6 Ton
 Weight to 80 lb to 84 lb to 46 lb

Turnbuckles

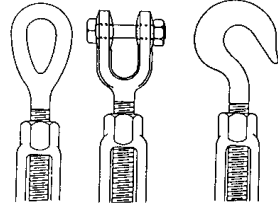

Hook end is about 2/3 as strong as EYE
 Take-up = 24" max, Need to Inspect

MODULE 4 - LIFTING AND RIGGING

RIGGING FITTINGS

- Ring, hook, and shackle components of slings should be made from forged alloy steel.
- Basic components:
 - Hooks
 - Shackles
 - Eyes
- Provide means of hauling (lifting) loads without directly tying to the load.
 - Can be attached to wire or fiber rope, blocks, or chains.
 - Used when loads too heavy for hooks to handle.
 - Hooks need latch or mouse closing/securing device.
- **Mousing**
 - Process of closing the open section of a hook to keep slings / straps from slipping off the hook.
 - Can mouse hooks using rope yarn, seizing wire or shackle.
- **Shackles**
 - Check rating stamp and WL rating.
 - Pins not interchangeable with other shackles.
 - Screw pin in all the way and back off $\frac{1}{4}$ turn before loading.

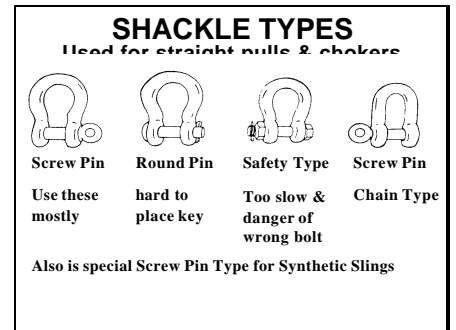
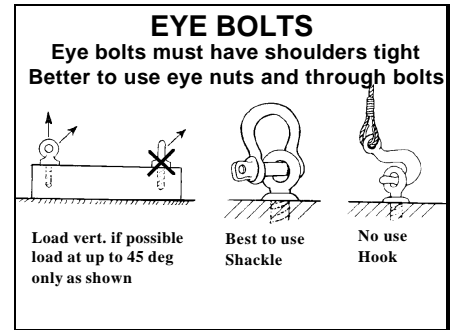

MODULE 4 - LIFTING AND RIGGING

OVERVIEW OF CRANES USED FOR COLLAPSE RESCUE

■ Pre-incident information:

- Develop and maintain listing of businesses with crane resources including crane equipment, crane operators and crane rigging equipment.
- Develop telephone call-up list for crane resources listed.
- Develop an identification and vendor call-back system for verification of incident needs and projected response time to the incident scene and confirming on scene contact person and their location.

TYPES OF MOBILE CRANES

commonly utilized in rescue operations at collapsed structure

■ **HYDRAULIC CRANES**

- Mounted on mobile chassis. (some have AWD & AWS)
- Have outriggers, which need to be set on firm bearings, and some have “on rubber” lifting capacities.
- Self-contained. (except for 120 Tons and greater)
- Relatively fast to set up.
- Rated by lifting capacity, in tons, at a distance of 10 ft from the center of the crane .
- The variable length boom makes them very useful in a US&R incident.

■ **ROUGH TERRAIN (RT) CRANES**

- “Pick and carry” capabilities
- Rated for “on rubber” or driving with loads
- More adapt to rough terrain, but still must be level to lift.

■ **CONVENTIONAL CRANE (Lattice Boom Cranes)**

- Normally requires more than one load to haul the boom components, counter weights, and rigging.
- Has a longer set up time than the hydraulic crane
- Rated by lifting capacity, in tons, at a distance of 10 ft from the center of the crane .
- Requires considerably more set up area than the hydraulic crane.

■ Lifting capacity of all cranes is reduced the farther away the center of the cranes is from the load.

- They are, essentially a very complicated 1st class lever

CRANES USED FOR COLLAPSE RESCUE

- Pre-Incident Information
 - List of resources available in your area.
 - Develop a telephone call-up list
 - Know projected response times

HYDRAULIC CRANES

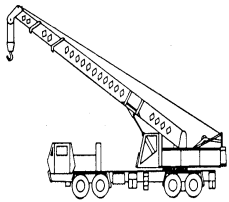

- On mobile chassis
 - some AWD & AWS
- Uses outriggers
- Self-contained
- Fast to set up
- Rated by lifting capacity in tons
 - At 10 ft radius
- Variable length boom

ROUGH TERRAIN CRANES



- Referred to as RT or pick and carry crane
- Have “on rubber” capacity rating
- More adapt to traveling on uneven surfaces
 - still need to be level to lift

CONVENTIONAL CRANES (Lattice Boom)

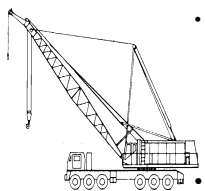

- Components usually hauled on several trucks
 - Rigging
 - Jib
 - Counterweight
 - Boom
- Determine boom length at initial setup

FOR ALL CRANES

- Maximum lifting capacity is reduced the farther the crane is from the load.
- They are a very complex 1st class lever

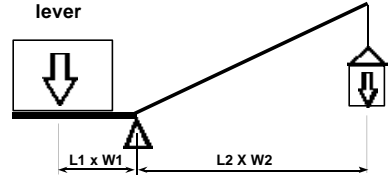

MODULE 4 - LIFTING AND RIGGING

REQUESTING THE APPROPRIATE CRANE

- Prepare for crane request by using standard US&R forms.
 - 20 questions and Form are on final pages of this module
- Be sure to describe potential load weights and load materials so that the right size crane, the right rigging equipment, and the right personnel can be matched and sent to the incident.
- Reach distance should be calculated from suitable crane lifting location or locations.
 - This assessment should be completed by identifying suitable location(s) that would accommodate aerial ladder operations
 - Distance is measured from the center pin on crane turntable to the center of gravity of the load.
 - Generally, the larger (either load capacity or reach) the , the longer the response time and a larger area is required for effective operation.
 - Conventional cranes may require an area as large as 35ft x 200ft for boom assembly, adjacent to lifting area
- Ensure sufficient access to the area before crane's arrival:
 - Access road condition and width.
 - Overhead clearance. (including power lines near site)
 - Room and conditions to maneuver around the site
- Rescue personnel must be assigned to facilitate crane operations:
 - Communicate with the crane operator
 - Assist the crane operator and riggers
- Rescuers should prepare for crane operations:
 - Anticipate the best location for crane operation & setup.
 - Initiate clearing activities prior to the arrival of the crane.
 - Is surface sloped or level?
 - Is surface hard or soft?
 - Obstacles and hazards:
 - Buildings
 - Walls
 - Wires

REQUESTING THE APPROPRIATE CRANE

- Estimate the potential load
- Provide access to the scene
- The bigger the crane the longer the response and set-up time.
- Answer 20 questions and use US&R Crane Form

BASIC REQUIREMENTS RELATED TO ON-SCENE CRANE OPERATIONS

- Assign Heavy Equipment & Rigging Spec + Rescue person as crane liaison.
- Prepare for crane operations.
 - Pick best location
 - Clear debris from set-up area
- Must have knowledge of hand signals.

SUMMARY

- | | |
|-------------------------------|------------------------------|
| • Gravity | • Levers and inclined planes |
| • Center of gravity | • Pulleys |
| • Friction | • Air bags |
| • Equilibrium | • Calculating weights |
| • Moment of force | • Anchor systems |
| • Mechanics, energy, and work | • Anchor failure |
| • Mechanical advantages | • Anchor spacing |

SUMMARY

- | | |
|---------------------------------------|--------------------------------|
| • Swivel hoists | • Sling arrangements |
| • Steel angles | • Critical angles |
| • Concrete screws | • Chains |
| • Wire rope | • Types of cranes |
| • Wire rope fittings and terminations | • Considerations for crane use |
| • Wire rope tighteners | • Crane hand signals |
| • Sling types | |

MODULE 4 - LIFTING AND RIGGING

20 QUESTIONS to ANSWER WHEN ORDERING A CRANE

When you contact a rental source of heavy lift equipment, they will start asking questions to permit them to give you what you need. If you can have answers to their questions ready beforehand, you will speed the process considerably. If you have answers to the following questions, you will be well prepared for the rental agent's questions.

1. Who are you and what are you doing?
2. How quickly do you want a machine?
3. What do you intend for this machine to do?
 - Pick and swing
 - Pick and carry
 - Lift large objects at small distance
 - Lift small objects at large distance
4. Will multiple machines be needed? (Second machine to set up primary machine).
5. What are the capabilities of the onsite crew? (Are they qualified to assist with set up?)
6. If this machine is for a single task, what is the load weight and what is the load radius?
7. If this is for multiple tasks, what are several combinations of load and distance? Max load / min distance, max distance / min load, possible mid load/mid distance?
8. Will this task require pick and carry capability?
9. What are the limits of room available for operation of the machine? Overhead clearance, tail swing clearance, underground obstructions?
10. Is there a place to assemble boom (if lattice) and crane (counterweights)? Including room for assisting crane?
11. Are there limitations on delivery of crane or parts? Posted bridges, low clearances, underground utilities?
12. What areas of operation are anticipated? Over rear, Over side, Over front, On rubber?
13. Are two crane (simultaneous) picks anticipated?
14. Will work be performed on a continuous (24 hr) basis? Is auxiliary lighting available?
15. Will radio communication be required to control load? Are dedicated radios available?
16. How much boom is required? Are special boom features (offset, open-throat) needed?
17. What size hook block is needed? Are shackles to fit hook available?
18. Will jib be needed? Jib length? Offset? Load?
19. Are additional rigging components needed? Load cell, lift beams, slings, shackles?
20. Who is the contact person and who is the person directing the rigging operations?

MODULE 4 - LIFTING AND RIGGING

BASIC CRANE HAND SIGNALS

Rescue personnel must have a basic knowledge of hand signals normally used to communicate with the crane operator.

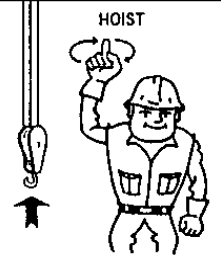
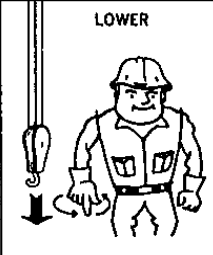
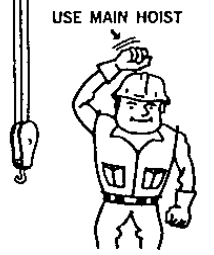
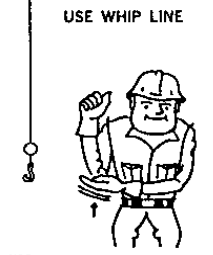
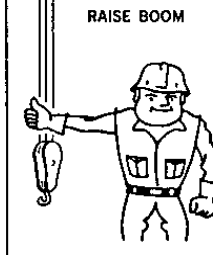
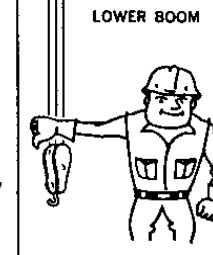
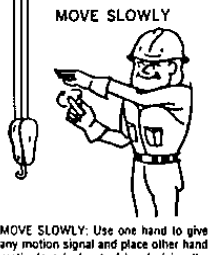
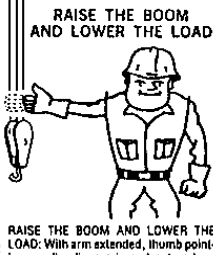
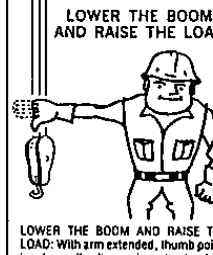
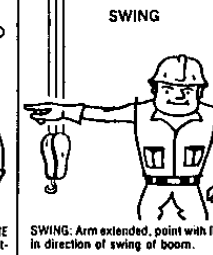
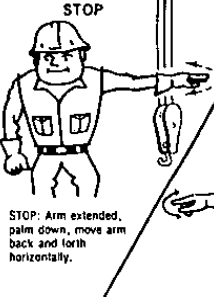
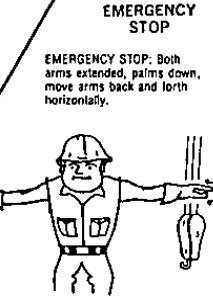
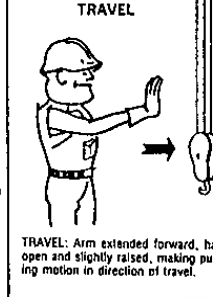
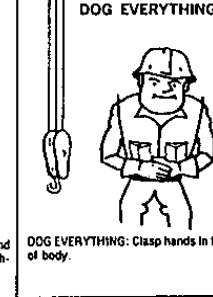
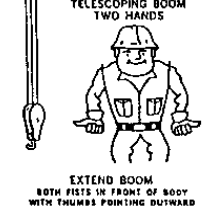
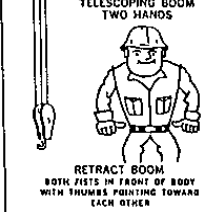
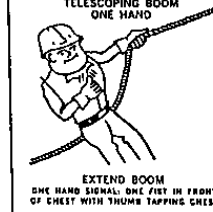
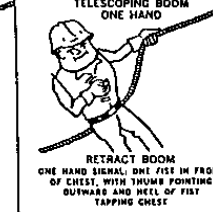
<p>CRANE SIGNALS</p> <p>ALWAYS STAND IN CLEAR VIEW OF YOUR CRANE HOIST ENGINEER</p> <p>BE SURE TO STAY A SAFE DISTANCE FROM HOOK, BLOCK OR BOOM</p> <p>Published by SPECIALIZED CARRIERS & RIGGING ASSOCIATION</p> <p>In accordance with the American National Standards Institute</p>		<p>HOIST</p>  <p>HOIST: With forearm vertical, forefinger pointing up, move hand in small horizontal circles.</p>	<p>LOWER</p>  <p>LOWER: With arm extended downward, forefinger pointing down, move hand in small horizontal circles.</p>
<p>USE MAIN HOIST</p>  <p>USE MAIN HOIST: Tap fist on head, then use regular signals.</p>	<p>USE WHIP LINE</p>  <p>USE WHIP LINE (Auxiliary Hoist): Tap elbow with one hand; then use regular signals.</p>	<p>RAISE BOOM</p>  <p>RAISE BOOM: Arm extended, fingers closed, thumb pointing upward.</p>	<p>LOWER BOOM</p>  <p>LOWER BOOM: Arm extended, fingers closed, thumb pointing downward.</p>
<p>MOVE SLOWLY</p>  <p>MOVE SLOWLY: Use one hand to give any motion signal and place other hand motionless in front of hand giving the motion signal. (Hoist slowly shown as example)</p>	<p>RAISE THE BOOM AND LOWER THE LOAD</p>  <p>RAISE THE BOOM AND LOWER THE LOAD: With arm extended, thumb pointing up, flex fingers in and out as long as load movement is desired.</p>	<p>LOWER THE BOOM AND RAISE THE LOAD</p>  <p>LOWER THE BOOM AND RAISE THE LOAD: With arm extended, thumb pointing down, flex fingers in and out as long as load movement is desired.</p>	<p>SWING</p>  <p>SWING: Arm extended, point with finger in direction of swing of boom.</p>
<p>STOP</p>  <p>STOP: Arm extended, palm down, move arm back and forth horizontally.</p>	<p>EMERGENCY STOP</p>  <p>EMERGENCY STOP: Both arms extended, palms down, move arms back and forth horizontally.</p>	<p>TRAVEL</p>  <p>TRAVEL: Arm extended forward, hand open and slightly raised, making pushing motion in direction of travel.</p>	<p>DOG EVERYTHING</p>  <p>DOG EVERYTHING: Clasp hands in front of body.</p>
<p>TELESCOPING BOOM TWO HANDS</p>  <p>EXTEND BOOM BOTH FISTS IN FRONT OF BODY WITH THUMBS POINTING OUTWARD</p>	<p>TELESCOPING BOOM TWO HANDS</p>  <p>RETRACT BOOM BOTH FISTS IN FRONT OF BODY WITH THUMBS POINTING TOWARD EACH OTHER</p>	<p>TELESCOPING BOOM ONE HAND</p>  <p>EXTEND BOOM ONE HAND SIGNAL: ONE FIST IN FRONT OF CHEST WITH THUMB TAPPING CHEST</p>	<p>TELESCOPING BOOM ONE HAND</p>  <p>RETRACT BOOM ONE HAND SIGNAL: ONE FIST IN FRONT OF CHEST, WITH THUMB POINTING OUTWARD AND HEEL OF FIST TAPPING CHEST</p>

