

TBI



Tall Buildings Initiative Guidelines for Performance- Based Seismic Design of Tall Buildings

Version 2.03

May 2017

Developed by
Pacific Earthquake Engineering Center
Report No. 2017/06

Sponsored by
Charles Pankow Foundation
ACI Foundation (Concrete Research Council)
American Institute of Steel Construction
Federal Emergency Management Agency
Structural Engineering Institute of ASCE (SEI)
Structural Engineers Association of California



Cover image: © Foster + Partners

Guidelines for Performance-Based Seismic Design of Tall Buildings

Developed by the
Pacific Earthquake Engineering Research Center (PEER)
as part of the
Tall Buildings Initiative

PEER Report 2017/06
Pacific Earthquake Engineering Research Center
Headquarters at the University of California, Berkeley

May 2017

DISCLAIMER

The Pacific Earthquake Engineering Research Center, the University of California, Charles Pankow Foundation, other project funding agencies, and the individual contributors to this document and their employers offer no warranty, either expressed or implied, as to the suitability of these Guidelines for application to individual building projects.

REVISION HISTORY

Version 2.00 released April 2017.

Version 2.01 released 18 May 2017 to correct Equations (6-2) and (6-4) and minor typographical errors.

Version 2.02 released 6 September 2017 to correct Page 4-12, which should read

Δ_{ult}^*	=	ultimate deformation capacity at which point characteristic strength of the component is lost or where the component loses the resistance to resist vertical gravity loads
------------------	---	--

Correction to page 6-12 should be as follows: ACI 318-14 specifies $R_n \left(\frac{A_c}{A_{cc}} \right) \left(\frac{2\sqrt{f_c}}{f_t} \right)$

Version 2.03 was released 9 October 2017 to correct Equations (6-1) and (6-2), and to move the definition for the “B” term to Page 6-9.

List of Participants

Jack Baker, Ph.D., P.E.
Professor
Stanford University

Jonathan Bray Ph.D., P.E.
Faculty Chair in Earthquake Engineering
Excellence
University of California, Berkeley

C.B. Crouse, Ph.D., P.E.
Principal Engineer/Vice President
AECOM

Gregory Deierlein, Ph.D., P.E.
John A. Blume Professor in the School of
Engineering
Stanford University

Ronald O. Hamburger, S.E. (Chair)
Senior Principal
Simpson Gumpertz & Heger, Inc.

John Hooper, S.E.
Senior Principal
Magnusson Klemencic Associates, Inc.

Marshall Lew, Ph.D., G.E.
Vice President and Principal Engineer
AMEC Foster Wheeler

Joe Maffei, Ph.D., S.E.
President
Maffei Structural Engineering

Stephen Mahin, Ph.D., P.E.
Byron L. and Elvira E. Nishkian
Professor of Structural Engineering
University of California, Berkeley

James O. Malley, S.E.
Senior Principal
Degenkolb Engineers, Inc.

Jack P. Moehle, Ph.D., P.E. (Co-Chair)
Ed & Diane Wilson Professor of Structural
Engineering
University of California, Berkeley

Farzad Naeim, Ph.D., S.E.
President
Farzad Naeim, Inc.

Jonathan P. Stewart, Ph.D., P.E.
Professor
University of California, Los Angeles

John Wallace, Ph.D., P.E.
Professor
University of California, Los Angeles

Executive Summary

These *Seismic Design Guidelines for Tall Buildings* present a recommended alternative to the prescriptive procedures for seismic design of buildings contained in the *ASCE 7* standard and the *International Building Code (IBC)*. The intended audience includes structural engineers and building officials engaged in seismic design and review of tall buildings. Properly executed, these Guidelines are intended to result in buildings that are capable of reliably achieving the seismic performance objectives intended by *ASCE 7*, and in some aspects, and where specifically noted, somewhat superior performance to such objectives. Individual users may adapt and modify these Guidelines to serve as the basis for designs intended to achieve higher seismic performance objectives than specifically intended herein.

The Pacific Earthquake Engineering Research Center published a first edition of these Guidelines in 2010 in response to the growing use of alternative performance-based approaches for seismic design of tall buildings. Major innovations introduced in that volume included: use of Service-Level Earthquake (SLE) shaking to evaluate building response to frequent earthquakes coupled with a specific collapse-resistance evaluation for Maximum Considered Earthquake (MCE_R) shaking, use of nonlinear dynamic analysis; explicit evaluation of global, system-based performance criteria in addition to individual element or member-based criteria; introduction of the concept of critical and non-critical elements; and explicit evaluation of cladding adequacy for MCE_R demands.

In the time since the publication of the 2010 Guidelines, the profession has gained substantial experience in application of these techniques to design of buildings around the world, and, in particular, the western United States. Also, the *ASCE 7* standard has been amended substantially, in no small part based on influence from the first edition of this document. Additionally, significant advances have been made in nonlinear analytical capability and in defining ground motions for use in nonlinear seismic analysis. Initially, buildings designed using performance-based procedures were assigned to Risk Category II; these buildings were structurally regular and typically utilized concrete core wall systems for lateral resistance. Individual project development teams have extended the use of performance-based seismic design of tall buildings to encompass other structural systems, building complexes that include irregular structures and multiple towers on a single podium, and numerous structures assigned to higher Risk Categories. This second edition addresses lessons learned in application of the first edition on many projects and the conditions, knowledge, and state-of-practice that presently exist.

These Guidelines include the seismic design of structural elements normally assigned as part of the seismic-force-resisting system as well as structural elements whose primary function is to support gravity loads. Except for exterior cladding, design of nonstructural components is not specifically included within the scope of these Guidelines. Design for nonstructural systems should conform to the applicable requirements of the building code or other suitable alternatives that consider the unique response characteristics of tall buildings.

Acknowledgments

The Pacific Earthquake Engineering Research Center (PEER) prepared the first edition of this Guideline under its Tall Buildings Initiative organized with funding or in-kind support from the California Emergency Management Agency, the California Geological Survey, the California Seismic Safety Commission, Charles Pankow Foundation, the City of Los Angeles, the City of San Francisco, the Federal Emergency Management Agency, the Los Angeles Tall Buildings Structural Design Council, the United States National Science Foundation, the Southern California Earthquake Center, the Structural Engineers Association of California, and the United States Geological Survey. The Charles Pankow Foundation, in particular, provided support for the development of the Guidelines.

The Charles Pankow Foundation provided renewed support for this second edition. The ACI Foundation (Concrete Research Council), American Institute of Steel Construction, the Structural Engineering Institute of ASCE (SEI), United States Federal Emergency Management Agency, and Structural Engineers Association of California provided additional financial and/or in-kind support.

The Seismology Committee of the Structural Engineers Association of California provided substantive review and recommendations for improvement of these Guidelines during their development. In addition, Dr. James R. Harris provided important insight into the reliability basis inherent in Load and Resistance Factor techniques adopted by the materials standards, and modified herein for application to seismic design.

Glossary

Action – A strain, displacement, rotation or other deformation resulting from the application of design loads.

Deformation-controlled action – An action expected to undergo nonlinear behavior in response to earthquake shaking, and which is evaluated for its ability to sustain such behavior.

Force-controlled action – An action that is not expected to undergo nonlinear behavior in response to earthquake shaking, and which is evaluated on the basis of its available strength.

Critical action – A force-controlled action, the failure of which is likely to lead to partial or total structural collapse.

Ordinary action – A force-controlled action, the failure of which might lead to local collapse comprising not more than one bay in a single story.

Noncritical action – A force-controlled action, the failure of which is unlikely to lead to structural collapse.

Backstay Effect – The set of lateral forces developing within a podium structure to equilibrate the lateral forces and moment of a tower extending above the podium structure. This condition is common to tall core wall buildings in which the core extends into a stiff basement structure braced by stiff basement walls around the perimeter.

Capacity Design – A design approach wherein the structure is configured and proportioned to restrict yielding and inelastic behavior to specific deformation-controlled actions for which structural detailing enables reliable inelastic response without critical strength decay, and which, through their plastic response, limit the demands on other portions of the structure such that those other parts can be designed with sufficient strength to reliably remain essentially elastic.

Coefficient of Variation – A standardized measure of the dispersion or probability distribution associated with response parameter, calculated as the ratio of the standard deviation to the mean value.

Conditional Mean Spectrum – The expected response spectrum conditioned on occurrence of a target spectral acceleration at a selected period.

Ergodic Models – Ground motion models that include a site term to account for average site effects in the databases used in their development. See Section 3.2.1.

Expected Strength – The probable peak strength of a material, or the probable peak strength of a structural element considering expected material strength and bias in the calculation model, as opposed to nominal or specified strength as commonly used in building codes.

Fault Parallel – Motion along an azimuth parallel to the direction of fault strike.

Fault Normal – Motion along an azimuth perpendicular to the direction of fault strike.

Fling Step – Characteristic of near-fault ground motion associated with elastic rebound of the Earth's crust, characterized by large-amplitude velocity pulse and a monotonic step in the displacement history.

Hazard Curve – A plot of the mean annual frequency of exceedance of a ground motion intensity parameter as a function of the ground motion intensity parameter.

Hazard Level – A probability of exceedance within a defined time period (or return period) at which ground shaking intensity is quantified.

Monotonic Loading – Loading of a structural component in which the displacement increases monotonically without unloading or reloading.

Nominal Strength – The strength of an element, calculated using specified material properties and the strength formulation specified by the applicable materials standard, before application of a resistance (strength reduction) factor.

Residual Story Drift Ratio – The value of story drift ratio at a location in a structure at rest, following response to earthquake motion.

Return Period – The average time span between shaking intensity that is equal to or greater than a specified value, also known as the recurrence interval; the annual frequency of exceeding a given intensity is equal to the reciprocal of the return period for that intensity.

Risk-Targeted Maximum Considered Earthquake Shaking – The level of shaking specified by the ASCE 7 standard as a basis for derivation of design ground motions.

Rupture Directivity – Effects associated with the direction of rupture propagation relative to the project site.

Scenario Spectrum – A site-specific response spectrum constructed for a specific magnitude earthquake along a particular fault. The scenario may also include definition of epicentral location, rupture propagation direction, and other parameters.

Service-Level Earthquake Shaking – Ground shaking represented by an elastic, damped, acceleration response spectrum that has a return period of 43 years, approximately equivalent to a 50% exceedance probability in 30 years.

Site Response Analysis – Analysis of wave propagation through a soil medium used to assess the effect of local geology on the ground motion.

Story Drift Ratio – The difference, at a specific instance of time, in lateral deflections at two adjacent horizontal levels divided by the vertical distance between the levels, commonly taken along principal axes of the building.

Transient Story Drift Ratio – The maximum absolute value of story drift ratio that occurs during a single response history analysis.

Uniform Hazard Spectrum – A site-specific, acceleration response spectrum constructed such that the ordinate at each natural period has the same exceedance probability or average return period.

Abbreviations

ACI	American Concrete Institute
AISC	American Institute of Steel Construction
ASCE	American Society of Civil Engineers
CQC	Complete quadratic combination
DE	Design Earthquake, defined by ASCE 7-16 as the earthquake effects that are two-thirds of the corresponding Maximum Considered Earthquake (MCE_R) effects
EOR	Engineer of Record
FEMA	Federal Emergency Management Agency
GMPE	Ground motion prediction equation
IBC	International Building Code
LRFD	Load and resistance factor design
MCE_R	Risk-targeted Maximum Considered Earthquake
PBD	Performance-based design
PSHA	Probabilistic seismic hazard analysis
$RotD_{D50}$	Ground motions oriented so as to produce geometric mean response
$RotD_{100}$	Ground motions oriented so as to produce maximum response
SLE	Service-Level Earthquake
SSI	Soil–structure interaction
USGS	United States Geological Survey

Notation

A_{cv}	Gross area of concrete section bounded by web thickness and length of wall section in the direction of shear force
A_g	Gross area of cross section
A_x	Torsional amplification coefficient calculated in accordance with ASCE 7 Section 12.8.4.3

A_{sw}	Area of web of steel section
A^*_x	Coefficient used to determine if accidental torsion needs to be considered in nonlinear analysis
B	Factor to account for conservatism in nominal resistance
C_d	Deflection amplification factor, as defined in ASCE 7
D	Dead loads, or related internal moments, forces, or deformations, including effects of self-weight and permanently attached equipment and fixtures, as defined in ASCE 7
D_{5-95}	Duration of an earthquake record, during which 90% of the record's energy is expended, computed calculated as an integral of the square of the acceleration
d_b	Bar diameter
E	Effect of horizontal and vertical earthquake-induced forces
E_c	Modulus of elasticity of concrete
$(EI)_{trans}$	Flexural rigidity of cracked transformed section of steel-reinforced coupling beam
E_M	Expected value of the capacity-limited earthquake load on the action, as defined in the applicable material standard (ACI 318, AISC 341)
E_s	Modulus of elasticity of steel, taken as 29,000 ksi (200,000 MPa)
E_X	Earthquake loads, or related internal moments, forces, or deformations, resulting from earthquake shaking applied along the principal axis of building response designated as the X -axis
E_Y	Earthquake loads, or related internal moments, forces, or deformations, resulting from earthquake shaking applied along an axis that is orthogonal to the X -axis
F_a	Short-period site coefficient (at 0.2 s), as defined in ASCE 7
f'_{ce}	Expected compressive strength of concrete
f'_c	Specified compressive strength of concrete
F_{PGA}	Site coefficient for PGA, as defined in ASCE 7
F_r	Post-peak residual yield strength of a component under monotonic loading
f_u	Specified ultimate strength of steel or steel reinforcement
f_{ue}	Expected ultimate strength of steel or steel reinforcement
F_v	Long-period site coefficient (at 1.0 s), as defined in ASCE 7
f_y	Specified yield strength of structural steel or steel reinforcement
F_y	Effective yield strength of a component under monotonic loading
f_{ye}	Expected yield strength of structural steel or steel reinforcement
f_{yt}	Specified tensile strength of structural steel or steel reinforcement
G_c	Shear modulus of concrete, commonly taken as $0.4E_c$
G_s	Shear modulus of steel, taken as 11,500 ksi (7900 MPa)

h	Story height, or coupling beam depth
h_w	Height of entire wall from base to top, or height of wall segment or wall pier considered
H	Height of the roof above the grade plane for damping calculation, or height of basement wall for seismic earth pressure
I_e	Seismic importance factor
I_g	Moment of inertia of gross concrete section about centroidal axis, neglecting reinforcement
K_e	Elastic (secant) stiffness up to the yield point of a component
l	Clear span of coupling beam
L	Live load
l_w	Shear wall length
M_{ne}	Expected moment strength of a beam
M_{pe}	Expected plastic moment capacity of a beam
M_W	Moment magnitude, a logarithmic scale for measure of earthquake size, as characterized by the amount of strain energy released by the event
P	Vertical force above a structural level
Q	Characteristic stress resultant (force or moment) in a structural component
Q_{ns}	That portion of the load on an element resulting from dead, live, and effects other than seismic
Q_T	The total demand, including gravity and seismic loading calculated by analysis
R	Response modification coefficient, as defined in ASCE 7
R_r^*	Residual strength from cyclic backbone
R_u^*	Peak strength on a cyclic backbone
R_n	Nominal (or specified) strength of an element, as defined in the applicable materials standards (AISC 341, AISC 360, ACI 318)
R_{ne}	Expected component strength
R_u	Peak strength on a monotonic backbone
R_y	Effective yield strength
S_{MS}	Site-adjusted MCE_R short-period spectral acceleration
u_{FIM}	Foundation input motions that are modified to account for the effects of base-slab averaging and foundation embedment
u_g	Free-field ground motion
V	Seismic base shear
V_{s30}	Average shear wave velocity in the upper 30 m of soil
V_{s30}^B	Value of V_{s30} at the base of the profile
γ	Load factor from ASCE 7 Chapter 16
δ	Lateral displacement

$\delta_{max,t}$	Maximum story drift at level “x” calculated considering inherent torsion
$\delta_{max,ta}$	Maximum story drift at level “x” calculated considering inherent plus accidental torsion
δ_u	For deformation-controlled actions, that largest deformation at which the hysteretic model is deemed valid given available laboratory data or other substantiating evidence
Δ	Characteristic component displacement
Δ^*_p	Plastic deformation to the peak strength on cyclic backbone
Δ^*_{pc}	Plastic deformation of the descending portion of cyclic backbone
Δ^*_{ult}	Ultimate deformation capacity
Δ_p	Plastic deformation to the peak strength point on monotonic backbone
Δ_{pc}	Plastic deformation of the descending portion of monotonic backbone
ε	Number of logarithmic standard deviations that a spectral response acceleration value lies above (+) or below (-) the median value at a given period
ε_s	Steel yield strain
ζ	Fraction of critical damping
θ	Elastic stability coefficient
Θ	Characteristic component rotation
λ	Modification factor to reflect the reduced mechanical properties for lightweight concrete relative to normal-weight concrete of the same compressive strength
μ	Mean value of a population of values
ρ	Redundancy factor based on the extent of structural redundancy present in a building, as defined in ASCE 7
ρ_{\square}	Ratio of area of distributed transverse reinforcement to gross concrete area perpendicular to that reinforcement
σ	Standard deviation of a population of values
ϕ	Resistance (strength reduction) factor as obtained from appropriate material standard
ϕ_s	Seismic resistance (strength reduction) factor
Ω_0	Overstrength factor, as defined in ASCE 7

Contents

List of Participants	v
Executive Summary	vii
Acknowledgments	ix
Glossary	xi
Abbreviations	xiii
Notation	xiii
Table of Contents	xvii
List of Tables	xxiii
List of Figures	xxv
1 INTRODUCTION	1-1
1.1 Purpose	1-1
1.2 Applicability	1-1
1.3 Use of these Guidelines	1-3
1.4 Interpretation	1-4
1.5 Limitations	1-4
2 DESIGN PROCESS, RISK CATEGORY, AND PERFORMANCE OBJECTIVES	2-1
2.1 Scope	2-1
2.2 Design Process	2-1
2.2.1 Confirm Design Process	2-1
2.2.2 Establish the Risk Category of the Building.....	2-2
2.2.3 Establish Performance Objectives	2-3
2.2.4 Seismic Input.....	2-5
2.2.5 Conceptual Design.....	2-5
2.2.6 Basis of Design	2-6
2.2.7 Preliminary Design.....	2-6
3 GROUND MOTION CHARACTERIZATION	3-1
3.1 Scope	3-1
3.2 Ground Motion Hazard Analysis	3-1
3.2.1 Probabilistic Seismic Hazard Analysis	3-1
3.2.2 Deterministic Seismic Hazard Analysis	3-4
3.3 Target Spectra	3-5

3.4	Site Response analysis	3-6
3.5	Near-Fault Effects	3-8
3.6	Selection and Modification of Ground Motion Records	3-9
4	MODELING AND ANALYSIS	4-1
4.1	Scope	4-1
4.2	General	4-1
4.2.1	System Idealization	4-1
4.2.2	Drift and Drift Ratio Demands	4-3
4.2.3	Component Force and Deformation Demands	4-3
4.2.4	Floor Diaphragms	4-4
4.2.5	Seismic Mass, Torsion, and Expected Gravity Loads	4-5
4.2.6	Load Combinations	4-6
4.2.7	Equivalent Viscous Damping	4-6
4.2.8	P-Delta Effects	4-8
4.2.9	Vertical Ground Motion Effects	4-9
4.3	Linear Analysis (Service Level).....	4-9
4.3.1	Response Spectrum Analysis	4-9
4.3.2	Response History Analysis	4-10
4.4	Nonlinear Analysis (Service or MCE_R Level)	4-10
4.4.1	Important Modeling Parameters.....	4-10
4.4.2	Methods for Establishing Component Properties	4-13
4.4.3	Component Analytical Models	4-13
4.4.4	Residual Drift Demands	4-14
4.4.5	Ground Motion Duration.....	4-15
4.5	FOUNDATION MODELING AND SOIL–STRUCTURE INTERACTION	4-16
4.5.1	Soil-Structure Interaction Effects	4-16
4.5.2	Modeling Subterranean Components	4-18
4.5.3	Foundation-Level Ground Motions.....	4-20
4.5.4	Seismic Pressures on Basement Walls	4-20
4.6	Structural Modeling Parameters	4-21
4.6.1	Expected Material Strengths	4-22
4.6.2	Expected Component Strengths	4-23
4.6.3	Effective Member Stiffness	4-23
4.6.4	Structural Steel Components	4-25
4.6.4.1	Steel beams in bending	4-25
4.6.4.2	Steel columns in bending.....	4-25
4.6.4.3	Steel beam-column joint panel zones.....	4-26
4.6.4.4	Steel column bases.....	4-26
4.6.4.5	Steel EBF link beams.....	4-26

4.6.4.6	Steel axially loaded braces	4-26
4.6.4.7	Steel buckling-restrained braces	4-27
4.6.4.8	Steel plate shear walls	4-27
4.6.5	Reinforced Concrete Components.....	4-27
4.6.5.1	Reinforced concrete beams in bending.....	4-27
4.6.5.2	Reinforced concrete columns in bending.....	4-28
4.6.5.3	Reinforced concrete beams and columns in shear	4-28
4.6.5.4	Reinforced concrete slabs in slab–column frames.....	4-28
4.6.5.5	Reinforced concrete beam–column joints	4-28
4.6.5.6	Reinforced concrete shear walls in bending and shear.....	4-28
4.6.5.7	Reinforced concrete coupling beams	4-30
4.6.5.8	Non-standard components	4-30
4.6.6	Response Modification Devices.....	4-31
5	SERVICE-LEVEL EVALUATION	5-1
5.1	Scope.....	5-1
5.2	General System Requirements	5-1
5.2.1	Structural System Design	5-1
5.2.1	Evaluation Criteria.....	5-1
5.3	Seismic Hazard Representation.....	5-2
5.4	Structural Modeling and Analysis.....	5-3
5.4.1	General	5-3
5.4.2	Torsion	5-4
5.4.3	Foundation–Soil Interface	5-4
5.4.4	Subterranean Levels.....	5-4
5.5	Design Parameters and Load Combinations	5-4
5.5.1	Load Combinations: Linear Modal Response Spectrum Analysis.....	5-4
5.5.2	Load Combinations: Linear Response History Analysis.....	5-5
5.5.3	Load Combinations: Nonlinear Response History Analysis	5-5
5.6	Global Acceptance Criteria.....	5-5
5.6.1	Story Drift Limit.....	5-5
5.7	Component Acceptance Criteria–Linear Analysis	5-6
5.7.1	Deformation-Controlled Actions	5-6
5.7.2	Force-Controlled Actions	5-6
5.8	Component Acceptance Criteria– Nonlinear Analysis	5-7
5.8.1	Deformation-Controlled Actions	5-7
5.8.2	Force-Controlled Actions	5-7

6	MCE_R EVALUATION	6-1
6.1	Scope.....	6-1
6.2	General Requirements	6-2
6.2.1	Structural System Design	6-2
6.2.2	Torsion Sensitivity Check.....	6-2
6.2.3	Evaluation Criteria.....	6-3
6.3	Seismic Hazard Representation.....	6-4
6.4	Structural Modeling and Analysis.....	6-4
6.5	Load Combinations	6-5
6.6	Quantification of Global and Local Demands.....	6-5
6.7	Global Acceptance Evaluation.....	6-6
6.7.1	Unacceptable Response.....	6-6
6.7.2	Peak Transient Story Drift.....	6-7
6.7.3	Residual Story Drift	6-7
6.8	Component Acceptance Criteria.....	6-7
6.8.1	General	6-7
6.8.2	Deformation-Controlled Actions	6-8
6.8.3	Force-Controlled Actions	6-9
6.9	Proportioning and Detailing	6-12
6.9.1	General Requirement.....	6-12
6.9.2	Prescriptive Code Requirements for Proportioning and Detailing	6-13
6.9.3	Cladding Systems	6-13
7	PRESENTATION OF RESULTS	7-1
7.1	Scope.....	7-1
7.2	General	7-1
7.3	Basis of Design	7-1
7.4	Geotechnical/Seismic Ground Motion Report.....	7-2
7.5	Preliminary/Conceptual Design	7-2
7.6	Design in Accordance with the Building Code Design Earthquake Requirements	7-3
7.7	Service-Level Evaluation	7-3
7.8	Maximum Considered Earthquake Evaluation	7-3
8	PROJECT REVIEW	8-1
8.1	The Requirements for Independent Peer Review.....	8-1
8.2	Selection and Reporting Requirements	8-1

8.3	Scope of Work	8-2
8.4	Peer Review Process	8-3
8.5	Design Responsibility	8-5
8.6	Dispute Resolution.....	8-5
8.7	Post-review Revision	8-6
9	REFERENCES.....	9-1
APPENDIX A SEISMIC INSTRUMENTATION.....		A-1
A.1	General	A-1
A.2	Instrumentation Plan Documentation and Review.....	A-1
A.3	Minimum Number of Channels.....	A-1
A.4	Instrument Locations	A-2
A.5	Installation and Maintenance	A-3
A.6	Data Dissemination	A-3
APPENDIX B BASIS OF DESIGN.....		B-1
B.1	General	B-1
B.2	Content.....	B-1
B.2.1	Building Description and Location.....	B-1
B.2.2	Codes and References	B-2
B.2.3	Performance Objectives.....	B-2
B.2.4	Gravity Loading Criteria	B-3
B.2.5	Seismic Hazards	B-3
B.2.6	Wind Demands.....	B-4
B.2.7	Load Combinations	B-4
B.2.8	Materials.....	B-5
B.2.9	Analysis.....	B-5
B.2.10	Acceptance Criteria.....	B-5
B.2.11	Test Data to Support New Components, Models, and Software	B-6
B.2.12	Appendices	B-6
APPENDIX C DESIGN-EARTHQUAKE EVALUATION.....		C-1
C.1	General	C-1
C.2	Exceptions	C-1
C.3	Ground Motion.....	C-1
C.4	R , C_d , Ω_0 , and ρ Factors.....	C-2
C.5	Redistribution of Coupling Beam Forces.....	C-2

APPENDIX D PRELIMINARY DESIGN	D-1
D.1 General	D-1
D.2 System Configuration	D-1
D.3 Multiple Towers on a Common Podium	D-4
D.4 Structural Performance Hierarchy	D-4
D.5 Wind.....	D-5
D.6 Higher-Mode Effects.....	D-6
D.7 Seismic Shear Demands.....	D-7
D.8 Building Deformations	D-7
D.9 Setbacks and Offsets	D-8
D.10 Diaphragm Demands.....	D-8
D.11 Outrigger Systems	D-8
D.12 Non-Participating Elements.....	D-9
D.13 Foundations	D-9
D.14 Slab–Wall Connections.....	D-10
D.15 Slab–Column Connections.....	D-10
APPENDIX E TYPICAL FORCE-CONTROLLED ACTIONS AND CATEGORIES.....	E-1

List of Tables

Table 4-1 Sources of deterioration.4-13
Table 4-2 Expected material strengths.4-22
Table 4-3 Reinforced concrete effective stiffness values.4-24
Table 6-1 Seismic resistance factors, ϕ_s6-12
Table A-1 Minimum number of channels of instrumentation. A-2
Table C-1 Recommended values of R factors. C-2
Table E-1 Force-controlled actions and categories..... E-1

List of Figures

Figure 4-1	Idealized Structural System.....	4-2
Figure 4-2	Equivalent viscous damping versus building height based on Equation (4-1).....	4-8
Figure 4-3	Idealized component response curves and parameters.....	4-11
Figure 4-4	Typical monotonic backbone curve (red curve), cycle test data (blue curve), and first-cycle envelope curve (heavy broken black curve) (Tremblay <i>et al.</i> , 1997).	4-12
Figure 4-5	Illustration of analytical model options.....	4-15
Figure 4-6	Schematic illustration of alternative models of buildings with basements.	4-17
Figure 4-7	Dual-system wall-frame building structure with independent foundations supporting wall and columns.	4-19
Figure 4-8	Core-wall tower with podium having separate foundation system.....	4-19
Figure 4-9	Examples of panel zones in structural walls.....	4-30
Figure D-1	Large changes in stiffness and mass.	D-1
Figure D-2	Lateral system with bracing elements repositioned over height.	D-2
Figure D-3	Two towers on a common base.....	D-2
Figure D-4	Column transfer and offset conditions.....	D-2
Figure D-5	Building geometry resulting in gravity-induced shear forces.	D-3
Figure D-6	Diaphragms with limited connectivity to vertical seismic-force-resisting elements.....	D-3
Figure D-7	Higher-mode effects on demand distributions in a tall core-wall building.....	D-7
Figure D-8	Illustration of outriggers used to reduce overturning demands at base of vertical elements of the seismic-force-resisting system.	D-9

1 Introduction

1.1 PURPOSE

The purpose of these Guidelines is to provide a performance-based procedure for earthquake-resistant design of tall buildings as an alternative to the prescriptive procedures of ASCE 7 and other standards incorporated by reference into the *International Building Code (IBC)*.

Commentary: *Use of these Guidelines constitutes an alternative or non-prescriptive approach that takes exception to one or more of the prescriptive requirements of the IBC by invoking Section 104.11 of that code. Section 104.11 reads as follows:*

104.11 Alternate materials, design and methods of construction and equipment. *The provisions of this code are not intended to prevent the installation of any material or to prohibit any design or method of construction not specifically prescribed in this code, provided that any such alternative has been approved. An alternative material, design or method of construction shall be approved where the building official finds that the proposed design is satisfactory and complies with the intent of the provisions of this code, and that the material, method or work offered is, for the purpose intended, not less than the equivalent of that prescribed in this code in quality, strength, effectiveness, fire resistance, durability, and safety*

ASCE 7-16 Section 1.3.13 also permits the use of alternative performance-based approaches. Section 1.3.1.3 states:

1.3.1.3 Performance-based Procedures. *Structural and nonstructural components and their connections designed with performance-based procedures shall be demonstrated by analysis in accordance with Section 2.3.6 or by analysis procedures supplemented by testing to provide a reliability that is generally consistent with the target reliabilities stipulated in this section. Structural systems subjected to earthquake shall be based on the target reliabilities in Tables 1.3-2 and 1.3-3. The analysis procedures used shall account for uncertainties in loading and resistance.*

1.2 APPLICABILITY

The design recommendations apply to the seismic design of buildings having the unique seismic response characteristics of tall buildings including:

- A fundamental translational period of vibration significantly in excess of 1 second
- High mass participation and lateral response in higher modes of vibration
- A seismic-force-resisting system with a slender aspect ratio such that substantial portions of the lateral drift result from axial deformation of the walls and/or columns as compared to shearing deformation of the frames or walls.

Commentary: *The dynamic response of typical tall buildings considered in the development of these Guidelines includes first translational mode mass participation in the range of 40% to 70% of the total, with approximately 90% mass participation represented in each principal direction of response when the first three to four translational modes are considered. While the procedures outlined in these Guidelines may be applicable to*

structures having different dynamic properties and characteristics, careful consideration of the effect of these characteristics on selection and scaling of ground motions, as well as interpretation of response results, is recommended in such cases.

These Guidelines consider the seismic hazard typical in the western United States and the building code criteria for the design of structures subject to these hazards. Such structures are intended to resist strong earthquake motion through inelastic response of their structural components. These recommendations may be applicable to the seismic design of structures that do not exhibit substantial inelastic response or that are located in regions with seismicity somewhat different than the western United States. In such applications, evaluate if modifications to the Guidelines are appropriate.

These Guidelines are written with the intent that a building properly designed in accordance with these Guidelines should be capable of achieving the seismic performance objectives intended by ASCE 7 for buildings of specified Risk Category. Individual users may adapt and modify these Guidelines to serve as the basis for designs intended to achieve other seismic performance objectives.

Commentary: *ASCE 7 Table 1.3.2 establishes target maximum probabilities of structural collapse given MCE_R shaking of 10% for Risk Category I and II structures, and 5% and 2-1/2%, respectively, for Risk Category III and IV structures. Table 1.3.3 establishes acceptable failure probabilities of 25%, 15%, and 9% for individual components or equipment anchorages given MCE_R shaking.*

ASCE 7-16 established the acceptable collapse probabilities based on work reported in FEMA P695 Quantification of Seismic Performance Factors. Using the reliability procedures described in that publication, well-configured structural systems conforming to the requirements of ASCE 7 and its referenced standards can be shown to generally meet these criteria without substantial margin. However, the actual performance of structures in recent U.S. earthquakes suggests that real structures perform much better than this, as observed collapse rates have been much lower. Several reasons the FEMA P695 procedures may over-estimate the real collapse risk is that: (1) the prototype structures used in the evaluations are intentionally designed to the minimum code criteria, without any additional strength or stiffness; (2) the procedures assume that reliability can be represented through lognormal distributions, which have large tails at the low and high ends of the distributions; and (3) the procedures for evaluating uncertainty result in large dispersion.

These Guidelines do not actually require implementation of the FEMA P695 procedures. Instead, these Guidelines establish acceptance criteria for evaluation of the acceptability of MCE_R shaking that have been derived using the same concepts as the FEMA P695 procedures. These Guidelines should be deemed to conform to the requirements of ASCE 7-16 with regard to performance-based approaches.

Structural design for resistance to loadings other than those associated with earthquakes is beyond the scope of this document. The design of nonstructural components other than exterior cladding for seismic resistance is also not included within the scope of this document. Design for these loadings and systems should conform to the applicable requirements of the building code or other suitable alternatives that consider the unique response characteristics of tall building structures.

1.3 USE OF THESE GUIDELINES

These Guidelines are compatible with, but amplify and amend, the requirements of ASCE 7-16. When using these Guidelines for design prior to the official adoption of ASCE 7-16, include the use of that edition of the standard as a project-specific exception to the building code. When adopting modifications to ASCE 7-16 recommended herein, include these modifications as exceptions as well, regardless of the adoption status of ASCE 7-16.

Ensure that the design team has the requisite knowledge and experience in subjects of ground-shaking hazards, selection of structural systems for resistance to earthquake shaking, nonlinear dynamic structural response and analysis, and structural proportioning and detailing necessary to achieve intended performance.

Commentary: *Proper execution of the Guidelines requires extensive knowledge of ground-shaking hazards, structural materials behavior, and nonlinear dynamic structural response and analysis. Engineers not possessing the requisite knowledge and skills can easily produce designs that will not perform as intended.*

Specify sufficient construction quality assurance to ensure that construction conforms to the requirements of the design.

Commentary: *Historically, many earthquake failures have been the result of construction that does not conform to the design intent. Structures designed using these criteria may require extensive nonlinear straining of structural elements. If appropriate construction quality assurance is not provided, the structure may not perform as intended.*

Prior to initiating a design using these recommendations, ascertain that this approach will be acceptable to the Authority Having Jurisdiction.

Commentary: *Acceptance of designs conducted in accordance with these procedures is at the discretion of the building official, as outlined under Section 104.11 of the building code. Each building official can, and some building officials have, declined to accept such procedures.*

Inform the Project Developer of the risks associated with the use of alternative procedures for design.

Commentary: *The design and permitting process for buildings designed in accordance with these Guidelines will generally entail greater effort and take more time than designs that strictly conform to the building code prescriptive criteria. Further, even in communities where the Authority Having Jurisdiction is willing to accept alternative designs, the development team bears a risk that the Authority Having Jurisdiction will ultimately decide that the design is not acceptable without incorporation of structural features that may make the project undesirable from cost or other perspectives.*

Provide peer review by qualified experts as part of the design process.

Commentary: *Most buildings designed in accordance with these Guidelines are expected to sustain damage when subjected to strong ground shaking. Some stakeholders may deem that this damage exceeds reasonable levels and may attempt to hold the participants in the design and construction process responsible for this perceived poor performance. In this event, the Engineer of Record may be required to demonstrate that he or she has conformed to an appropriate standard of care. It may be more difficult to do this for buildings designed by alternative means than for buildings designed in strict conformance to the*

building code. Independent peer review by qualified experts, as described in Chapter 8, can help to establish that an appropriate standard of care was followed.

When taking exception to the recommendations provided herein, provide appropriate technical substantiation for these exceptions to the peer reviewer(s) and Authority Having Jurisdiction and obtain their approval.

Commentary: *The authors have endeavored to develop these Guidelines to be broadly applicable to the seismic design of most tall buildings, given present industry knowledge and practice limitations. However, no Guideline can anticipate every structure to which it may be applied, nor can it anticipate advances in the state-of-knowledge-and-practice. The authors do not intend to preclude the application of alternative techniques or approaches when these are appropriately substantiated, justified, and approved.*

1.4 INTERPRETATION

This Guideline consists of chapters and appendices. Primary guidance is generally in the form of (a) statements of scope and applicability and (b) imperative text that gives instructions on recommended procedures. The “Commentary” sections provide an explanation of the basis for these recommendations, explanation of how to implement the recommendations, and alternative approaches. The appendices provide supplemental guidance on specific topics as an aid to project teams, reviewers, and building officials. Individual project design and review teams may modify the guidance in these appendices as appropriate to their specific projects.

1.5 LIMITATIONS

These Guidelines are intended to provide a reliable basis for the seismic design of tall buildings based on the present state-of-knowledge, laboratory and analytical research, and the engineering judgment of persons with substantial knowledge in the design and seismic behavior of tall buildings. When properly implemented, these Guidelines should permit the design of tall buildings that are capable of seismic performance equivalent or superior to that attainable by design in accordance with present prescriptive building code provisions. Earthquake engineering is a rapidly developing field, and it is likely that knowledge gained in the future will suggest that some recommendations presented herein should be modified. Individual engineers and building officials implementing these Guidelines must exercise their own independent judgment as to the suitability of these recommendations for that purpose.

2 Design Process, Risk Category, and Performance Objectives

2.1 SCOPE

This chapter presents an overview of the recommended design process. It also provides guidance on Risk Category assignment, selection of performance objectives appropriate to that Risk Category, and classification of member actions as either Deformation-Controlled or Force-Controlled Actions.

2.2 DESIGN PROCESS

These Guidelines use a performance-based approach for seismic design of tall buildings. The sections below describe the basic steps of this design process.

2.2.1 Confirm Design Process

Prior to using these recommendations for design, confirm that the Authority Having Jurisdiction is amenable to performance-based design alternatives and the use of these Guidelines. In addition, confirm that the development team is aware of, and accepts, the risks associated with the use of alternative design procedures, that the engineer has the appropriate knowledge and resources, and that construction quality will be adequate to ensure that the design is properly executed. Section 1.3 provides additional discussion of these issues.

Commentary: *The International Building Code (IBC) specifies prescriptive criteria for building design. Section 104 of that code also permits the design professional to demonstrate through alternative means that a design that does not conform to the prescriptive criteria is capable of achieving equivalent or better performance than expected for similar buildings that do conform, subject to the approval of the Authority Having Jurisdiction. Most western United States jurisdictions have accepted the use of performance-based approaches for the seismic design of tall buildings, permitted under the Alternative Means clause of the code. However, not all jurisdictions permit this, and each jurisdiction that does, takes a somewhat different approach to the process. Some jurisdictions are relatively permissive with regard to structural system selection and design procedures, deferring to the design professional and peer reviewers for guidance; others are more restrictive and may impose rigid criteria and procedures. Before engaging in the design process, it is prudent to meet with the Authority Having Jurisdiction and develop a thorough understanding of the acceptability and any limitations on this approach that may be imposed.*

Design using alternative procedures poses some risks to the development team beyond those normally experienced when designing to the prescriptive building code criteria. Most jurisdictions require peer review as part of the approval process. Such peer review can substantially lengthen the design schedule as the Engineer of Record and peer reviewer(s) come to agreement on the design approach and, ultimately, the acceptability of the design itself. In some cases, the Engineer of Record and peer reviewer(s) may not come to complete agreement on all issues, posing the risk that the project may not be permitted. The

Engineer of Record can minimize, but not completely eliminate, these risks by properly managing the process, assuring the peer review is provided with timely and clear information on the design and project schedule, and responding to review comments in a forthright and open manner. Chapter 8 presents further discussion of these topics.

Another risk associated with the use of alternative procedures is that when a development team undertakes this approach it may be violating one or more of the prescriptive requirements of the building code. In the event that the building does not perform adequately, or is perceived to not perform adequately, the use of alternative procedures can make it more difficult to establish that an appropriate standard of care was followed. The peer review process can help to establish adherence to an appropriate standard of care.

2.2.2 Establish the Risk Category of the Building

Establish the Risk Category of the building in conjunction with the Authority Having Jurisdiction.

Commentary: *The Authority Having Jurisdiction should make the final assignment of Risk Category based on the requirements specified in the building code. These Guidelines provide the recommended technical approach to demonstrate that a tall building is capable of providing performance equivalent to that anticipated of buildings conforming to the prescriptive requirements for Risk Categories II, III, or IV.*

Risk Category assignments are defined through the building code consensus process at the national level. The current assignments, located in IBC Table 1604.5, are a culmination of decades of discussion and balloting. Some local jurisdictions have legislative authority to modify these assignments.

Under IBC Table 1604.5, Risk Category II is assigned when the building is not assigned to Risk Category I, III, or IV. Most tall buildings fit into this category. Risk Category III is assigned to “Buildings and other structures that represent a substantial hazard to human life in the event of a failure...” Included in this category are buildings “with an occupant load greater than 5000.” The IBC approach to calculating the number of occupants is based on egress considerations, which are intended to be conservative and typically result in occupant loads in excess of that normally present. Despite this conservative occupancy calculation, most residential towers will not exceed the 5000-person threshold. However, office buildings with a building area of approximately 750,000 sq. ft. or more will exceed this threshold.

In some cases, tall buildings may share a common podium with other buildings, resulting in a combined occupancy for the podium and supported buildings that exceeds the 5000-person threshold. In such cases, the Risk Category assignment should consider whether the multiple towers rely on overlapping areas for egress.

As noted, Risk Category assignments are the responsibility of the Authority Having Jurisdiction. For multiple towers on a common ground-level podium, some jurisdictions have adopted the approach of assigning the Risk Category for the podium based on the combined occupancy of the supported towers. For the case where Risk Category III is assigned, some jurisdictions only require that the enhanced acceptance criteria be applied through the plastic hinge region of towers that utilize concrete shear walls as their seismic-force-resisting system. This approach is based on the judgment that the most significant damage is likely to occur in the plastic hinge zone, and if these zones are protected, the building complex should perform to the expectations for a Risk Category III structure at, and

adjacent to, the podium level. Where seismic joints are provided at the podium level, the Risk Category should be assigned based solely on the occupancy within the bounds of the expansion joints because each building responds independently to the earthquake shaking.

2.2.3 Establish Performance Objectives

Select design Performance Objectives and design criteria appropriate to the Risk Category of the building except when the development team desires enhanced performance. When enhanced performance capability is desired, explicitly state in the Basis of Design both the desired performance and the means to be employed to achieve this performance.

Commentary: *Buildings designed in accordance with these Guidelines are intended to have seismic performance capability at least equal to, and in some respects superior to, that intended for similar buildings designed in full conformance with the prescriptive requirements of ASCE 7-16. As presented in the Commentary to FEMA P1050 (2015), the building code is intended to provide Risk Category II buildings the capability to:*

- *Withstand Risk-targeted Maximum Considered Earthquake (MCE_R) shaking, as defined in ASCE 7, with low probability (not more than 10%) of either total or partial collapse;*
- *Withstand Design Earthquake (DE) shaking, having an intensity two-thirds that of MCE_R shaking, without generation of significant hazards to individual lives such as falling debris or nonstructural components; and*
- *Withstand relatively frequent, more moderate-intensity earthquake shaking with limited damage.*

Buildings assigned to Risk Category III are intended to withstand MCE_R shaking with a 5% or smaller probability of either total or partial collapse. They also are likely, in general, to experience less damage in smaller earthquakes than comparable Risk Category II buildings. Buildings assigned to Risk Category IV are intended to withstand MCE_R shaking with a 2.5% or smaller risk of collapse. In addition, Risk Category IV buildings should be able to withstand most earthquakes that may affect them with sufficiently slight damage to permit immediate post-earthquake use for their intended function.

These Guidelines seek to satisfy these objectives through requirements to:

- *Proportion and configure structures using capacity design principles;*
- *Demonstrate that Risk Category II buildings are capable of essentially elastic response and limited structural damage under Service-Level Earthquake (SLE) shaking having a return period of 43 years (50% exceedance probability in 30 years);*
- *Demonstrate with high confidence that the building will respond to MCE_R shaking without loss of gravity-load-carrying capacity; without inelastic straining of important lateral-force-resisting elements to a level that will severely degrade their strength; and without experiencing excessive permanent lateral drift or development of global structural instability;*
- *Detail all elements of the structure for compatibility with the anticipated deformations of the seismic-force-resisting system under MCE_R shaking; and,*

- *Anchor and brace all nonstructural components and systems in accordance with the requirements of the building code, such that, under DE shaking, components and systems essential to protect life safety are anticipated to function, and other components and systems are anticipated to remain in place and not create falling hazards.*

In addition to the predominantly safety-related criteria addressed above, these Guidelines set a performance goal for SLE shaking to allow, at most, limited structural damage. Expected damage in response to SLE shaking may include minor cracking of concrete and yielding of steel in a limited number of structural elements. Expected damage should not compromise the ability of the structure to survive MCE_R shaking, nor should it result in unsafe conditions requiring repair prior to occupancy. Some repair may be needed to restore appearance or protection from water intrusion, fire, or corrosion. Expected nonstructural damage should be below the threshold that would limit post-event occupancy of the building. Notwithstanding these expectations, the uncertainties in ground motions and building performance analysis are such that some buildings designed in accordance with these Guidelines may experience damage exceeding the expectations expressed in this paragraph.

If a building is subjected to earthquake shaking more intense than SLE shaking, it may no longer be capable of providing serviceable behavior for subsequent shaking at SLE shaking unless appropriate repairs are implemented.

Tall buildings may house hundreds to thousands of individuals, either as residences or places of business. Therefore, it is desirable that such buildings remain operable immediately after SLE shaking. Such performance is achievable if minor structural damage occurs that does not affect either immediate or long-term performance of the building and, therefore, does not compromise safety associated with continued building use. Repair, if required, should generally be of a nature and extent that it can be conducted while the building remains occupied and in use, though some local disruption of occupancy around the areas of repair may be necessary during repair activities.

It is important to note that the fitness of a tall building for occupancy depends not only on its structural condition, but also on the functionality of key nonstructural components, including elevators, stairs, smoke evacuation systems, fire sprinklers and alarms, plumbing, and lighting. These Guidelines do not require direct verification of the ability of these elements to provide performance consistent with the structural performance objectives described in this section. Rather, these Guidelines assume that, as a minimum, these components and systems will be designed and installed in accordance with the requirements of the applicable building code and that such design will be adequate to provide the required protection for SLE shaking. Resources such as the FEMA P58 methodology enable more direct assessment of nonstructural performance for various levels of earthquake demand and can be used for this purpose if desired. If unique features of the building design result in response likely to increase the susceptibility of critical nonstructural components to failure, alternative means to protect these critical systems should be considered.

Even when a building is assigned to Risk Category II, it may be desirable to design the building to achieve performance superior to that which serves as the default for these Guidelines, as described above. Nothing contained in these Guidelines should be interpreted as preventing such design; however, it may be necessary to adopt modifications to the recommended design criteria contained herein to attain enhanced performance. Such modifications could include:

- *Selection of alternative, lower probabilities of exceedance for SLE shaking, MCE_R shaking, or both;*
- *Design of nonstructural components and systems to withstand shaking more intense or story drifts larger than that required by the building code;*
- *Use of acceleration floor response spectra obtained from the analysis to proportion nonstructural attachments; and*
- *Design to limit residual displacements as a means of increasing the probability that the building can be repaired following earthquake ground shaking.*

2.2.4 Seismic Input

Determine response spectra for SLE shaking and MCE_R shaking, and select and modify earthquake ground motion time series for use in nonlinear response history analysis in accordance with Chapter 3.

Commentary: *These Guidelines require analysis and design of buildings to meet specific acceptance criteria provided for both SLE and MCE_R shaking. ASCE 7-16, some jurisdictions, and some reviewers also require an evaluation of DE shaking, defined as two-thirds of the intensity of MCE_R shaking. This is not specifically required by these Guidelines; however, Appendix C provides recommended procedures when such a design step is required by the Authority Having Jurisdiction or peer reviewer(s).*

2.2.5 Conceptual Design

Select the structural systems and materials; their approximate configuration, proportions and strengths; and the intended primary mechanisms of inelastic behavior. Apply capacity design principles to establish the target inelastic mechanisms.

For all members of the structural system, define deformation-controlled actions and force-controlled actions. Categorize each forced-controlled action as being Critical, Ordinary, or Noncritical.

Commentary: *The Engineer of Record is to identify deformation-controlled actions and force-controlled actions, and is to categorize force-controlled actions as being Critical, Ordinary, or Noncritical, subject to approval by the peer review.*

Deformation-controlled actions are those that are expected to undergo nonlinear behavior in response to earthquake shaking and that are evaluated for their ability to sustain such behavior. Force-controlled actions are not expected to undergo nonlinear behavior in response to earthquake shaking and are evaluated on the basis of available strength. Critical force-controlled actions are those whose failure is likely to lead to partial or total structural collapse. Noncritical force-controlled actions are those whose failure is unlikely to lead to structural collapse. Ordinary force-controlled actions are those whose failure might lead to local collapse but are unlikely to affect the overall stability of the structure.

Appendix E provides a list of typical force-controlled actions and recommended categories. Individual design and peer review teams should consider this list when formulating the categorization of component actions for specific projects and supplement and modify as is appropriate to those projects.

2.2.6 Basis of Design

Prepare a formal Basis of Design document that describes: the building configuration; the structural systems and materials of construction; the anticipated mechanisms of inelastic response and behavior; the design performance objectives; the specific design and analysis measures to be conducted to demonstrate acceptable performance capability; the deformation-controlled and force-controlled actions, including categories; and all exceptions to the prescriptive building code provisions. Obtain approval of the Basis of Design from the Authority Having Jurisdiction and peer reviewer(s) prior to undertaking substantial design effort.

***Commentary:** Section 7.3 and Appendix B presents guidance on developing the Basis of Design.*

2.2.7 Preliminary Design

Design the building to resist dead, live, wind, snow, and other loadings prescribed by the building code. Use dynamic structural analysis to confirm that building dynamic behavior is acceptable and that designs will likely be capable of meeting the intended performance objectives.

***Commentary:** To perform a meaningful analysis, it is necessary to develop the building design to a sufficient level of detail to allow determination of the distribution of its stiffness, strength, and mass, as well as the hysteretic properties of elements that will undergo inelastic straining in response to strong ground shaking. Though not required by these Guidelines, many designers conduct an initial evaluation of the building for minimum prescriptive criteria specified by the building code. Appendix D presents information intended to help engineers developing preliminary designs.*

3 Ground Motion Characterization

3.1 SCOPE

Seismic design of tall buildings using these Guidelines requires characterization of ground motions at two levels: Service-Level Earthquake (SLE) and Risk-Targeted Maximum Considered Earthquake (MCE_R). This chapter provides guidance on the following topics:

1. Ground motion hazard analysis to develop acceleration response spectra at the SLE and MCE_R ground motion levels;
2. Selection of target spectra for ground motion record selection and modification;
3. Consideration of site-specific effects in developing the spectra from (1) and (2);
4. Consideration of near-source rupture directivity effects in developing the spectra from (1) and (2); and
5. Selecting and modifying appropriate ground motion records for response history analysis.

3.2 GROUND MOTION HAZARD ANALYSIS

Use seismic hazard analysis to compute appropriate acceleration response spectra for SLE and MCE_R shaking levels. Obtain SLE ground motions using probabilistic seismic hazard analysis (PSHA). Use both probabilistic and deterministic seismic hazard analysis, in accordance with ASCE 7 for MCE_R shaking.

Use a default viscous damping ratio of 5% for calculation of response spectral ordinates. If spectra for alternative damping ratios are desired, use adjustment factors from Rezaeian et al. (2014a) for horizontal-component ground motions and Rezaeian et al. (2014b) for the vertical component. Obtain peer review approval of other procedures used to determine damping-associated adjustment of response spectral ordinates.

3.2.1 Probabilistic Seismic Hazard Analysis

Perform PSHA for SLE shaking (43-year return period, 50% probability of exceedance in 30 years) and the MCE_R shaking level, as defined in ASCE 7. Use appropriate contemporary models for the description of regional seismic sources and ground motion models. Ensure that the models are properly implemented in the PSHA code being used. The mechanics of PSHA are described elsewhere (e.g., McGuire, 2004); this section assumes a basic familiarity with PSHA procedures. When conducting PSHA, account for epistemic (modeling) uncertainties in the seismic source characterization and ground motion models, and in the associated parameter values by including weighted alternatives in the analysis (i.e., logic-tree framework).

Commentary: PSHA requires the use of seismic source characterization models and ground motion models. The latest versions of seismic source models used in the generation

of USGS national seismic hazard maps can be found in USGS Open File Report 2014-1091 (Petersen et al., 2014).

Ground motion models provide the median and standard deviation of a ground motion Intensity Measure (IM) conditioned on parameters related to source (e.g., magnitude, focal mechanism), path (e.g., closest distance, position relative to hanging wall), and site (e.g., V_{S30} , basin depth).

For shallow crustal earthquakes in active crustal regions, use the NGA-West2 ground motion models (Bozorgnia et al., 2014). Different ground motion models are needed for subduction-zone regions and in stable continental regions. For such regions, use ground motion models implemented in the most recent USGS hazard maps and, as appropriate, more recent models that may better capture regionally significant conditions.

Commentary: *As an alternative to NGA-West2 (and similar) ground motion models, seismological simulation techniques can be considered to generate site ground motions for a prescribed earthquake source function coupled with wave propagation analysis. Dreger et al. (2015) present the validation of several such simulation methods, which have been recommended for the prediction of median ground motions in engineering application under certain conditions. Most of these techniques have not been calibrated to provide robust estimates of standard deviation, which is also needed for seismic hazard analysis.*

The lack of knowledge regarding which model to use within a particular component of PSHA is referred to as epistemic uncertainty. Epistemic uncertainty is ideally incorporated using a logic-tree framework with multiple viable values and associated weights of the critical source parameters and multiple ground motion prediction equations (GMPEs). Further details on PSHA in a logic-tree framework are provided in McGuire et al. (2005) and Bommer et al. (2005).

The USGS seismic hazard tool (<http://earthquake.usgs.gov/hazards/>) allows for PSHA and computation of MCE_R spectra for any location in the United States. The USGS site is well maintained and is kept current with respect to seismic source models and ground motion models. However, the USGS ground motions as currently configured are not site-specific for several reasons: (1) they are not specific to the site location but instead are interpolated from results at a grid of points, and (2) the USGS ground motions are for a reference site condition (at the site class B/C boundary), which are then modified for various site classes through multiplication of spectral ordinates by site coefficients in Chapter 11 of ASCE 7. This hybrid of probabilistic reference site ground motions deterministically modified for site amplification produces hazard estimates biased towards under-prediction (Goulet and Stewart, 2009). Additionally, multiplication with discrete site coefficients as opposed to smooth functions of site amplification introduces error. Pending revisions to the USGS site will allow the actual site V_{S30} to be used with site terms in ground motion models, which will avoid the biases from hybrid analysis and discrete site coefficients.

In principal, the most reliable ground motion estimates are provided by site-specific PSHA, in which the analyst selects the seismic source models and ground motion models that are most appropriate for the site. Site-specific PSHA uses the site location (latitude, longitude) and site condition for the site of interest, and can be performed using commercial codes and the open source code OpenSHA (Field et al., 2003). The main drawback to site-specific analysis is it requires knowledge of PSHA and the underlying models. Inadequate familiarity typically leads to misuse of the software and erroneous results. Therefore, users unfamiliar with PSHA tools and related models may consider using the USGS web site in lieu of site-specific analysis.

For sites that classify as near fault per ASCE 7 Chapter 11 (fault distance, as derived from deaggregation, ≤ 15 km for $M_W \geq 7$, or fault distance ≤ 10 km for $M_W \geq 6$), rupture directivity effects should be considered in analyses of ground motion hazard and target spectra. Section 3.5 describes this topic, and Section 3.6 provides additional considerations related to ground motion time series selection.

Use site parameters appropriate for ground-surface, free-field conditions. These site parameters typically include time-averaged shear wave velocity in the upper 30 m of the site (i.e., V_{S30} as defined in Chapter 20 of ASCE 7) and may also include additional basin depth parameters. Compute V_{S30} using measured shear wave velocities from the ground surface to a depth of 30 m.

Commentary: *Most ground motion models include a site term that accounts for average site effects in the (generally global) databases used in their development. Site amplification models of this type are referred to as ergodic (Anderson and Brune, 1999). Ergodic models represent seismic site response at a specific site in only a general sense based on the manner in which many other sites having similar V_{S30} affect the characteristics of ground motion. When using ergodic models, we prefer models that incorporate the effects of soil stiffness (V_{S30}), and sediment depth (Z1.0 and Z2.5) (e.g., most NGA-West2 models). We discourage the use of site amplification models based on soil categories due to steps in site amplification across category boundaries. Ergodic models should be used directly in the hazard computation instead of being applied as a deterministic modification of reference rock hazard, which introduces bias. In regions where subduction-zone earthquakes have a significant contribution to the hazard, the GMPEs for these earthquakes (as of this writing) do not have basin depth terms; therefore, alternative deterministic approaches to account for the effects of basins are recommended. Site-specific analysis of ground motion amplification effects is required per ASCE 7 for some soft-soil site conditions and their use can be beneficial regardless of site condition; Section 3.4 presents guidelines on analysis of this type. Site-specific analysis of ground motion amplification should not be confused with site-specific PSHA.*

Report the following outcomes of PSHA:

1. Mean ground motion hazard curves at the fundamental periods of the structure in both horizontal directions and a suitable number of higher-mode periods (corresponding approximately to higher modes that encompass 90% of the participating mass). It is also recommended to provide fractiles of ground motion at the selected hazard level (5%, 16%, 50%, 84%, 95%, equivalent to median plus or minus one and two standard deviations);

Commentary: *The intent of this requirement is to assure selection of a sufficient number of conditioning periods to capture the important response modes. Although it is common to use approximate first- and second-mode periods to condition scenarios, the first and second modes will often capture less than 80% of the mass in response. In such cases, it is possible to artificially enrich the spectrum at shorter periods so as to capture the needed additional modes. Alternatively, additional scenario spectra could be constructed at the shorter periods.*

2. Uniform hazard spectra associated with SLE and 2475-year ground motion levels. These spectra should extend beyond the building fundamental period to encompass shaking intensity at the effective (lengthened) building period; and
3. Acceleration response spectra for the MCE_R shaking level, which is modified from the 2475-year ground motion level through application of risk coefficients and maximum direction

coefficients. Compute the risk coefficients using Method 2 in ASCE 7. Although not preferred, the Method 1 risk coefficients may be used. Maximum direction coefficients convert median-component ground motions [referred to as RotD50-component (Boore, 2010)] to maximum direction ground motions.

Commentary: *We recommend the use of the Shahi and Baker (2014) model or a more recent consensus model for maximum direction coefficients.*

Perform deaggregation for the 2475-year return period ground motion level (and for the SLE if optional response history analysis is to be performed for this level). Perform the deaggregation for key structural periods to be considered in the derivation of scenario spectra (Section 3.3). The deaggregation results provide percentage contributions to the ground motion hazard as a function of the seismic source, earthquake magnitude, source-to-site distance, and epsilon¹.

When MCE_R ground motions are computed using site-specific PSHA, compare the resulting spectra to those obtained from standard procedures described in Chapter 11 of ASCE 7. Those standard procedures entail the use of reference-site MCE_R spectra (for $V_{S30} = 760$ m/s) from USGS maps, which are then modified using site factors (F_{PGA} , F_a , and F_v) in Chapter 11. As described in Chapter 21 of ASCE 7, MCE_R ordinates derived from site-specific PSHA shall not fall more than 20% below those provided by standard procedures in Chapter 11 of ASCE 7. When site-specific ground motion amplification effects are considered as part of site-specific PSHA, additional checks of the resulting amplification levels are recommended as described in Section 3.4. When both PSHA and ground motion amplification effects are considered on a site-specific basis, if the combined reductions of MCE_R ordinates relative to those produced by Chapter 11 procedures exceed 20%, obtain peer-review approval of an appropriate maximum permissible reduction (whether 20% or a larger amount).

Commentary: *We considered setting a value for a maximum allowable combined reduction when site-specific site response is used as part of site-specific PSHA, but such a value would be arbitrary. This matter should be taken up on an application-specific basis by appropriate peer reviewers.*

Ground motion reductions associated with soil–structure interaction effects, evaluated using procedures in Section 4.5, are independent of those associated with site-specific ground motion analyses. Such reductions should not be applied when checking the 20% (or other) limited described above. Section 4.5 suggests applicable limits for ground motion reductions from soil-structure interaction.

3.2.2 Deterministic Seismic Hazard Analysis

When deterministic seismic hazard analysis is performed per ASCE 7, use the same ground motion models and logic-tree weights used in the PSHA. Assign the same values to the independent parameters, such as V_{S30} and fault type, as assigned in the PSHA. Select the magnitude for the controlling fault based on the results of disaggregation of PSHA for the appropriate return period for SLE or MCE_R . Consider near-fault effects as described in Section 3.5.

Commentary: *Deterministic seismic hazard analysis has the same components as PSHA (e.g., seismic source characterization models and ground motion models). The primary*

1. ¹ Epsilon, or ϵ , is the number of standard deviations (σ_{\ln}) of an observation $\ln(z)$ above or below the mean (μ_{\ln}), computed as $\epsilon = [\ln(z) - \mu_{\ln}] / \sigma_{\ln}$.

differences are that deterministic seismic hazard analyses do not consider the ranges of possible magnitudes and associated recurrence rates for each seismic source nor uncertainties in the ground motion intensity measure given a specific event. A single earthquake on a given fault is considered with a prescribed magnitude and location. A single percentile-level of ground motion is taken from the ground motion model (e.g., the 84th percentile, which is the median plus one standard deviation in logarithmic units). Some parameter-value selections made in deterministic seismic hazard analyses are arbitrary. Nevertheless, ASCE 7 uses deterministic seismic hazard analysis to provide a deterministic cap on ground motion in regions near major active faults (Leyendecker et al., 2000) to limit ground motion to levels deemed “reasonable” for seismic design.

More than one fault may produce the largest ground motion response spectrum. For example, a major event (e.g., M_w 6–7) on a nearby fault may produce the largest ordinates of a response spectrum at short and intermediate natural periods, but a larger earthquake (e.g., M_w 8–9) on a fault farther away may produce the largest long-period ordinates as well as longer significant duration (D5-95).

3.3 TARGET SPECTRA

Develop horizontal target spectra for MCE_R level ground motions using the procedures in ASCE 7 Chapter 16. Method 2 is preferred for use with these Guidelines. Provide scenario spectra for a sufficient number of matching periods so as to provide 90% participating mass in each horizontal direction of the structure. Apply similar procedures for SLE if response history analyses are to be performed for that level.

Commentary: *Target spectra are defined as acceleration response spectra that provide the intended spectral shape and amplitude for ground motion time series used for response history analyses. Target spectra are normally defined for the MCE_R ground motion level. However, in cases where response history analysis is to be performed for the SLE, a target spectrum would need to be defined for it also.*

ASCE 7 Chapter 16 describes two options for specifying target spectra. Method 1 consists of a MCE_R spectrum based on Section 11.4.7 or Section 11.4.8 (smaller of 2475-year uniform hazard spectrum or an $\varepsilon = 1.0$ deterministic spectrum. For the SLE, the Method 1 spectrum can be taken as the 43-year uniform hazard spectrum. Method 2 consists of two or more site-specific target spectra, herein referred to as scenario spectra. A given scenario spectrum has an ordinate matching the MCE_R spectrum (or uniform hazard spectrum, in the case of SLE) at a specified matching period. While using scenario spectra for MCE_R motion has many advantages, this is typically not necessary for SLE analyses.

As needed, develop vertical target spectra using a separate hazard calculation to compute uniform hazard spectra for vertical ground motions directly or as the product of horizontal target spectra and period-dependent vertical/horizontal ratios appropriate for the magnitude, fault distance, and site condition that control the hazard.

Commentary: *Scenario spectra can be taken as conditional mean spectra or conditional spectra as defined by NIST (2011).*

The use of scenario spectra (ASCE 7 Method 2) is advantageous for sites subject to rupture directivity from near-fault ground motions, as explained in Section 3.5.

When modal periods are close (e.g., for similar modes in the two horizontal axes of the building), a single scenario spectrum can be used for those modes. In this case, the spectral ordinates for the scenario spectrum should match or exceed the MCE_R (or uniform hazard spectrum for the SLE case) between the two modal periods.

The fundamental periods of the structure used as matching periods should be as realistic as possible (i.e., include soil–structure interaction, when appropriate). The use of approximate period equations from the building code is discouraged for the identification of matching periods.

The use of NGA-West2 models are recommended for vertical-component ground motions or V/H spectral ratios for earthquakes in active crustal regions (e.g., Bozorgnia and Campbell, 2016; Gulerce and Abrahamson, 2011; Stewart et al., 2016). For applications outside of active crustal regions (e.g., subduction zones, stable continental regions), use vertical-component models specific to those regions if available; otherwise use V/H relations for active crustal regions with region-appropriate horizontal ground motion models.

3.4 SITE RESPONSE ANALYSIS

This section pertains to site response analysis procedures that take into account site data beyond the parameters incorporated into “ergodic” models (e.g., V_{S30} and basin depth). This additional information most often consists of dynamic soil properties and their distributions with depth to enable wave propagation analysis. When performed under the assumption of vertically propagating shear waves, such analyses are referred to as ground response analyses. Site response is a more general term encompassing additional processes that cause soil and rock motions to differ, including basin effects.

Commentary: *Ground motion models (e.g., NGA-West2) are derived from recordings subject to a wide variety of site effects, including shallow ground response, basin effects, and topographic effects. Accordingly, the effects of each site response mechanism are present in an average sense in the predictions of ground motion models.*

Perform site-specific ground response analyses when required by ASCE 7 Chapter 11 or when a refined assessment of site effects is desired. Follow recommended procedures [i.e., Stewart et al. (2014) and NCHRP (2012)] for developing required soil properties and their uncertainties, selecting a suite of input motion, performing ground response analyses, and interpreting the results in manner conducive for use with PSHA.

Commentary: *The results of ground response analyses are sensitive to choices made in each stage of the recommended procedures (site characterization, input motion selection, method of analysis, and interpretation). Accordingly, careful adherence to the guidelines and peer review are essential.*

If the bedrock is reasonably shallow and its depth is known, the profile used in ground response analysis should extend into rock, and input motions should be defined for the rock condition. If the site consists of deep soils that cannot be reasonably simulated in their entirety, then the soil profile should extend to a firm soil horizon, preferably below the depth of a significant impedance contrast.

Global average site conditions for a given V_{S30} typically involve relatively gradual increases of shear wave velocity with depth, which therefore represents the approximate condition reflected in ergodic models. Relative to the use of ergodic models, ground response

analyses provide the greatest benefit for site conditions that differ from V_{S30} -conditioned global averages. This can be the case for sites with especially steep velocity gradients typically associated with large impedance contrasts.

Ground response analyses do not provide a valid representation of site effects for periods beyond the elongated (from nonlinearity) fundamental period of the soil column used in the analysis. Site response at long periods is often critical for tall buildings that are the subject of these Guidelines. Stewart et al. (2014) describe procedures for merging the results of ground response analysis at short periods with ergodic models at long periods to reduce the potential for bias.

When ground motion recordings are available on or near the site, the data can be interpreted to infer site effects (Stewart et al. 2017). Such interpretations are a valuable supplement to ground response analysis, especially at long periods.

As described in Section 3.2, when site-specific PSHA is performed, with or without site-specific site response analysis, ASCE 7 Chapter 21 places a 20% limit on the level of ground motion reduction that can be applied relative to standard ground motion analysis procedures in Chapter 11. Those standard procedures entail the use of reference-site MCE_R spectra (for $V_{S30} = 760$ m/s) from USGS maps, which are then modified using site factors (F_{PGA} , F_a , and F_v) in Chapter 11.

Compare the calculated site-specific amplification to the estimations from ergodic models at MCE_R ground motion levels. A value of site-specific amplification that is up to 20% smaller than that obtained from ergodic models meets the intent of the ASCE 7 Chapter 21 check.

Commentary: *For this check, both the site-specific and ergodic amplifications should reflect the ground motion change between the ground surface and the base-of-profile condition, which is unlikely to be $V_{S30} = 760$ m/s. If the V_{S30} at the base of the profile is denoted V_{S30}^B , then the ergodic site amplification relative to V_{S30}^B can be computed as the difference (in natural log units) between the predicted site amplification for the surface V_{S30} and that for V_{S30}^B .*

Report the results of site response analyses using site-specific, period-dependent, amplification factors relative to base condition V_{S30}^B , where the factors are computed as the ratio of the surface response spectra to the response spectra of the base condition, typically referred to as the input outcrop motion. Apply these amplification factors in seismic hazard analyses (Section 3.2) to compute ground surface spectra for SLE and MCE_R conditions.

Commentary: *There are three general options for computing seismic hazard at the ground surface using site-specific amplification functions (McGuire et al., 2001; Stewart et al., 2014): (1) hybrid methods in which rock or stiff soil IMs for MCE_R and possibly SLE conditions are multiplied by the site amplification; (2) convolution methods in which the site amplification function—with its uncertainty—is convolved with the reference rock or stiff soil hazard curve; and (3) full implementation of the site-amplification function in the hazard calculation. Approach (1) produces biased results when site response is nonlinear (Goulet and Stewart, 2009). Although modifications to the hybrid approach (provided in Section 1.2.3 of Stewart et al. 2014) can be applied to reduce this bias, approaches (2) and (3) are preferred to hybrid methods. Refer to Stewart et al. (2014, 2017) for details on these methods and computational tools to support their application.*

Do not apply hybrid methods for cases in which the site-amplification checks produce greater than 20% reductions relative to ergodic models.

3.5 NEAR-FAULT EFFECTS

Sites located at close distance to large-magnitude earthquakes can be subject to near-fault rupture directivity effects and fling-step effects.

Rupture directivity may affect the development of ground shaking hazards as given in these Guidelines in the following respects:

1. RotD50-component ground motions may differ from those given by ground motion models (e.g., from NGA-West2). This affects the results of seismic hazard analysis (Section 3.2) and the development of target spectra (Section 3.3).
2. Whereas the orientation of maximum-component ground shaking is generally random and variable across periods, for some near-fault sites acceleration response spectral ordinates for long periods in the fault-normal (FN) direction are likely to be stronger than the RotD50 spectral ordinates. The level of increase in the FN direction cannot exceed the maximum component / RotD50 ratio.
3. Ground motions for sites subject to forward rupture directivity effects have an increased likelihood of having pulse-like characteristics in their velocity-time series.

Considerations (2) and (3) affect ground motion selection and application of the motions to the structural model (ASCE 7, Chapter 16, and Section 3.6 of these Guidelines).

Fling-step also has the potential to affect response spectra and ground motion time series. However, currently available models consider its effects solely as modifications to ground motion time series (Kamai et al., 2014; Burks and Baker, 2016). The remainder of this section is focused on near-fault effects on RotD50 acceleration response spectra produced by seismic hazard analysis; hence, only rupture directivity effects are considered. Section 3.6 discusses near-fault effects on ground motion selection and modification.

ASCE 7 Chapter 11 defines near-fault conditions as fault distances ≤ 15 km for $M_w \geq 7$ earthquakes and fault distances ≤ 10 km for $M_w \geq 6$ earthquakes. When deaggregation results indicate controlling faults meet these criteria, consider the site as near fault for the purpose of these Guidelines.

Commentary: Recent research indicates varying distance ranges for different types of near-fault effects. Models for rupture-directivity effects on RotD50-component response spectra predict such effects as extending to several tens of kilometers (Spudich et al. 2014), and similar distance ranges are applied in models for pulse probabilities, particularly for ground motions in the FN direction (e.g., Shahi and Baker, 2011; Hayden et al., 2014). The polarization of the strongest horizontal ground shaking in the FN direction tends to occur only at much closer fault distances, generally $< 3\text{--}5$ km (Watson-Lamprey and Boore, 2007). Despite these differing findings, in order to avoid confusion, these Guidelines retain the definition in ASCE 7 Chapter 11.

For near-fault sites, apply appropriate methods to account for rupture directivity effects on target acceleration response spectra used for ground motion selection (Section 3.3), especially for the

MCE_R ground motion level. Consider epistemic uncertainties associated with alternative directivity models, including the option of neglecting directivity.

Commentary: Five rupture directivity models were prepared as part of the NGA-West2 project (Spudich et al., 2014). These models predict the change in the RotD50 component of ground shaking from a directivity-neutral condition (from NGA-West2 ground motion models) to a condition specific to a site given its position relative to the ruptured fault segment and the hypocenter location. An expert panel has reviewed these models and provided recommendations for application (Donahue et al., 2016). The models were found to be reasonably consistent for strike-slip ruptures but substantially variable for reverse-slip, implying large epistemic uncertainty.

A challenge in applying these models in PSHA is to consider all possible hypocenter locations in future events. Donahue et al. (2016) review the NGA-West2 directivity models and provide recommendations regarding their use for hazard analysis. Three levels of sophistication are provided for considering alternate hypocenter locations across a fault surface. As of this writing, these capabilities are not incorporated into most PSHA codes. Until this capability is provided, the ground motion analyst has limited options for considering rupture directivity effects.

The use of a scenario earthquake option for analysis of the target spectrum simplifies the process. As given in the description of Method 2 in ASCE 7, the scenario is applicable for a specific magnitude and fault revealed by deaggregation, which in turn sets the fault distance. The remaining condition required to add a directivity component to the scenario event is hypocenter location. If the return period of full-segment ruptures on the fault is substantially shorter than the return period of ground motions, a condition of maximum rupture directivity can be conservatively assumed (hypocenter located relative to the site at the furthest location along-strike for strike-slip earthquakes or along-strike and down-dip for dip-slip earthquakes).

Using a scenario defined in this manner, the scenario spectrum for a directivity-neutral condition (ASCE 7 Method 2) can be modified using recommended directivity models. Further details and examples of this procedure are given in Donahue et al. (2016).

3.6 SELECTION AND MODIFICATION OF GROUND MOTION RECORDS

Select and modify ground motion records for structural dynamic analyses following procedures given in ASCE 7 Chapter 16 (Sections 16.2.2 and 16.2.3), with the limited exceptions noted below. The modification of selected ground motion records provides compatibility of the suite of records with target response spectra (Section 3.3), developed as appropriate in consideration of site-response or near-faults effects (Sections 3.4-3.5).

These Guidelines assume ground motion records are required for response history analysis of structures simultaneously in two horizontal directions, which is compatible with the objectives of ASCE 7 Chapter 16 record selection and modification criteria. As in ASCE 7, the minimum number of horizontal record pairs for each considered MCE_R-compatible target spectrum is 11. When ground motions are to be selected for the SLE, select seven record pairs if nonlinear response history analyses are to be performed or three record pairs if linear response analyses are to be used.

Commentary: As required by ASCE 7, select record pairs for each target spectrum that have general compatibility with the appropriate tectonic regime (e.g., active crustal regions,

subduction zones, stable continental regions) and controlling distance, magnitude, and site condition, utilizing the results of deaggregation of the seismic hazard at periods relevant to the structural response. The relevant structural natural periods should correspond to a sufficient number of modes so as to have a participating mass that is at least 90% of the structural mass.

For tall buildings, the fundamental period is often 4 s or greater. Deaggregation at these long periods requires the use of ground motion models that operate over a wide period range. Recent NGA-West2 models for active crustal regions (Bozorgnia et al., 2014) and one subduction-zone earthquake model (Abrahamson et al., 2016) are capable of estimating ground motions up to 10 s and hence can be useful for hazard computations and deaggregation. As part of its NGA project for subduction zones, PEER intends to release seven new ground motion prediction equations for these types of earthquakes in 2017.

When vertical accelerograms are required, use the vertical components that accompany pairs of selected horizontal motions. For a given three-component record, apply the same scaling to the vertical component as is applied to the horizontal. Check for compatibility of the scaled vertical component spectra with the target. Consider alternative methods if there is significant incompatibility between vertical-component motions developed with this procedure and the vertical target.

Commentary: *The recommended procedure for selecting and scaling vertical component motions is intended to provide compatibility between vertical and horizontal components by retaining, to the extent practical, their as-recorded relative amplitudes.*

If this compatibility is not achieved with the selected records, alternatives that could be considered include: (1) selecting a new set of records that retain needed attributes in their horizontal component while also providing more realistic vertical ground motions (desirable if the same scenario earthquake event controls the horizontal- and vertical-component hazard); and (2) develop horizontal- and vertical-component ground motions for a scenario event derived from deaggregation of vertical-component ground motions (these ground motions would be considered as an additional suite to those selected for the horizontal component).

When using multiple sources, having notably different magnitude/distance combinations and each contributing more than 20% of the relative contribution to hazard at a period of interest, select a minimum of five records for each of these significantly contributing seismic sources but not less than 11 records total.

Commentary: *The intent of this multi-source supplementary requirement for ground motion selection is to allow for different characteristics (spectral shape, duration, etc.) to be reflected in the ground motions used for dynamic analysis. It is recommended to use more than five records for events that contribute significantly to the controlling hazard (i.e., >20%). In some cases this may require the use of a total number of ground motion record pairs that exceeds the ASCE 7 minimum of 11.*

In cases where multiple fault sources contribute to the hazard beyond the 20% level, but the magnitudes identified from deaggregation are similar (i.e., within about 0.5 magnitude units), it is acceptable to combine these sources for the purpose of ground motion selection. The intent of this provision is to allow for separate suites of ground motions when attributes of controlling sources are notably distinct (e.g., San Andreas fault vs. smaller faults within urban coastal regions).

For evaluation in peer review, report the significant durations of selected and modified ground motions, and compare, as practical, with predictions from duration ground motion models.

Commentary: *Duration checks are a potentially important component of ground motion selection because long-period structures require motions of significant duration to generate response and because of the possible effects of strength or stiffness degradation in some structural components. For this reason, selected ground motions should reasonably reflect the anticipated duration of scenario earthquakes. See Afshari and Stewart (2016) and references therein for duration ground motion models for active crustal regions. Duration models for subduction regions are under development as of this writing as part of the NGA-Subduction project.*

As required by ASCE 7, the selected ground motions for a particular target spectrum should include an appropriate percentage of motions with near-fault pulse characteristics. For sites where pulse-type motions are considered, use not less than five records in the pulse or no-pulse subsets of the ground motion suite.

Commentary: *Pulse probabilities depend on magnitude, fault distance, and hypocenter location relative to site, among other factors (e.g., Shahi and Baker, 2011; Hayden et al., 2014; Almufti et al., 2015). As described in Section 3.5, the hypocenter position for these calculations can be taken so as to maximize forward directivity effects—and hence pulse probabilities—provided that the return period for the scenario earthquake magnitude is significantly less than 2475 years.*

NIST (2011) recommends procedures for identifying records having pulse-like characteristics.

At sites where some motions containing pulses should be selected, we recommend selection of at least five records having such characteristics so as to provide some statistical meaning to the effects of such pulses, without requiring an excessive number of motions; however, this requirement may require more than 11 records in the suite. In order to properly account for other variabilities, select a suite of motions having a ratio of impulsive and non-impulsive motions that is appropriate to the site hazard.

For near-fault sites in which the FN component is taken as the maximum-component direction (typically for rupture distances < 3–5 km, as indicated in Section 3.5), do not allow the median response spectrum of selected ground motions in the FP direction to fall below the applicable RotD50 spectrum evaluated per Section 3.5.

Commentary: *Because the orientation of ground motions, even in the near-fault environment, is highly uncertain, it is inadvisable to take advantage of a directional reduction that may or may not develop. This criteria can be met, as needed, by applying necessary modification (direct amplitude scaling or otherwise) to the FP components of ground motions. This may result in a suite of motions where the resultant response is somewhat higher than the typical vector sum of FN and FP components.*

Where significant fling-step effects are anticipated (typically at rupture distances < 10 km), and judged to be potentially important to the structural response, add such effects to selected time series in the slip-parallel direction (FP for strike-slip earthquakes, FN and vertical for reverse-slip earthquakes).

Commentary: *Ground motion time series from most databases [including the NGA-West2 database (Ancheta et al., 2014)], remove fling effects as part of the data processing. Hence, when such effects are anticipated for a site, they can be added to selected ground motions.*

Procedures for incorporating the fling step into ground motion time series are given by Burks and Baker (2016) and Kamaï et al. (2014). When fling-step effects are to be incorporated into ground motion time series, uncertainties in the key parameters (i.e., pulse period, displacement amplitude) should be considered.

4 Modeling and Analysis

4.1 SCOPE

This chapter provides guidance and requirements for elastic and inelastic dynamic analyses of the building structure and its foundation. The following documents provide further useful background and guidance on structural analysis and modeling:

- NEHRP Seismic Design Technical Brief No. 4: *Nonlinear Structural Analysis for Seismic Design* (2010)
- NIST: *Guidelines for Nonlinear Structural Analysis for Design of Buildings* (in preparation, 2017)
- ATC 72-1: *Modeling and Acceptance Criteria for Seismic Design and Analysis of Tall Buildings* (2010)
- NIST: *Soil-Structure Interaction for Building Structures* (2012)

Section 4.2 discusses general modeling and analysis topics. Section 4.3 provides recommendations for linear analysis, and Section 4.4 provides recommendations for nonlinear analysis. Section 4.5 provides guidance on modeling foundations and soil–foundation–structure interaction, and Section 4.6 provides guidance on structural component modeling.

4.2 GENERAL

4.2.1 System Idealization

Conduct analyses using a three-dimensional structural model that represents the spatial distribution of mass and stiffness to an extent adequate for calculation of the significant features of the dynamic response of the building. Include the intended lateral-force-resisting system as well as any vertical-load-bearing elements and nonstructural components expected to contribute significant lateral stiffness and strength under the anticipated deformations. Construct the model to represent reasonably the geometry and finite size of members and components, including areas of overlap between members (e.g., panel zone regions of beam–column connections, wall–coupling beam geometries, braced-frame connections, uplift effects due to flexural elongation of walls, etc.).

Define all modeling parameters to represent the expected, or best estimate, stiffness and strength of the components, using mean or median values from structural material or component tests. Similarly, model the seismic mass and gravity loads to represent the expected self-weight of the building.

Commentary: *Three-dimensional mathematical structural models are required for all analyses to reliably represent the overall building response and transfer of forces in and out of the lateral system components through floor diaphragms and through the foundation (e.g., see Figure 4-1). Given the current state of modeling capabilities and available software*

systems, there is no reason to estimate the actual three-dimensional behavior of tall buildings by relying on approximate two-dimensional models. The accuracy obtained by using three-dimensional models substantially outweighs the advantage of the simplicity offered by two-dimensional models.

Although analytical models used to perform linear (elastic) analysis as part of the prescriptive building code procedures typically do not include representation of elements other than those that compose the intended lateral-force-resisting system, in tall buildings the gravity-load-carrying system and some nonstructural components can add significant stiffness and strength. Because the goal of the analysis procedures used in these Guidelines is to reliably estimate seismic response, it is important to include such elements in the analytical model and to verify that their behavior will be acceptable. However, analyses conducted to demonstrate conformance with prescriptive requirements of the code, rather than evaluate performance, must be limited to the lateral-force-resisting system, as intended by ASCE 7.

The decision as to which components and behaviors to include in the structural model requires engineering knowledge and judgment. For instance, if adequate safeguards are taken against excessive shear deformations and shear failure in reinforced concrete components (walls, beams, and columns) through the use of appropriate capacity design concepts, then simulation of shear deformations might not be warranted. But such decisions will require a careful review of analysis results to verify that the analysis assumptions made are indeed justified, and might require post-analysis strengthening or a re-analysis if the assumptions made are shown to be incorrect.

Because the goal of the analyses is to estimate the central tendency of response, the model parameters, including structural stiffness and strength, gravity loads, and mass, should represent the central tendency values. In a strict statistical sense, this implies use of median (50th percentile) values of all the model parameters. However, given the uncertainty and paucity of data, it is generally acceptable to define the model parameters based on either median or mean values. Exceptions to this are instances where modeling parameters are varied to conduct sensitivity analyses. Typical cases include stiffness of soil springs and effective stiffness of transfer diaphragms.

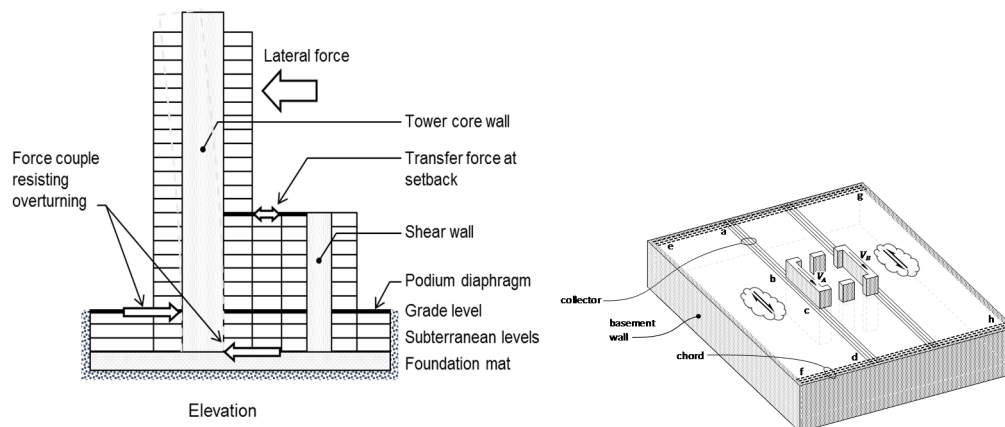

Figure 4-1 Idealized Structural System.

4.2.2 Drift and Drift Ratio Demands

Track peak transient and residual drifts and story drift ratios recorded along the two orthogonal axes of the building plan, up the building height. Monitor drifts at multiple points in the floor plan to identify building twist. Report the drifts and story drift ratios at locations in the floor plan where the drifts are largest.

Where there are significant differences in vertical displacements across the floor plan, monitor vertical displacements to assess racking deformations imposed on structural and nonstructural components.

Commentary: *Peak drifts and residual drifts, as well as story drift ratios, are primary earthquake demand parameters evaluated in the SLE and MCE_R evaluations of Chapters 5 and 6. Monitoring building twisting is suggested to help understand the building behavior.*

Some structures, such as concrete core walls, may experience large vertical displacements due to earthquake overturning effects, which can increase deformations in certain structural and non-structural components. For example, core wall uplift can magnify the rotations in slab-wall, slab-column, or slab- and beam-wall joints, which should be considered when evaluating deformation demands in these joints. Vertical wall deformations also increase the racking deformations that non-structural partition walls (and other components) experience, beyond the measured story drifts. Therefore, the effect of vertical deformations should be considered if FEMA P58 (2010) or similar types of damage assessments are being conducted.

4.2.3 Component Force and Deformation Demands

Track force and deformation demands in structural members and components. Report the average and peak values for comparison against specified acceptance criteria, and check maximum peak values to confirm that the demands are within the permissible modeling range. Additional demand measures, such as cumulative deformations or displacement velocities, may also be required to evaluate certain components.

In members and components having force-controlled actions, report stress resultants including axial force, shear force, and moments, as applicable. Document the methods and assumptions used to determine the reported forces for evaluation of consistency with the acceptance criteria.

In members and components having deformation-controlled actions, report strains, axial or shear deformations, and rotations, as applicable. Document methods and assumptions used to determine the reported strains or deformations for evaluation of consistency with the acceptance criteria.

Commentary: *Chapters 5 and 6, respectively, specify acceptance criteria for force and deformation demands for SLE and MCE_R evaluations. These evaluations may use the average over multiple ground motions of peak values experienced during the suite of response history analyses. In other cases, the evaluations may use peak values in individual ground motions to determine whether an individual analysis run produced acceptable response. In some cases, other demand measures may be required, such as cumulative deformation demands in steel buckling-restrained braces or peak velocities in viscous dampers.*

In addition to the specified SLE and MCE_R acceptance criteria, peak force and deformation demands should also be checked in all analyses to confirm that they do not exceed the

permissible range of the analysis model. The specific limits will depend on the capabilities of the analysis model. Where the demands exceed the permissible range, then the analysis may be deemed invalid, referred to here as an “unacceptable response.”

To the extent that the reported force (or moment) demands are sensitive to assumptions used in their calculation, these assumptions should be clearly stated. Where forces are calculated by explicit integration of stresses over a region, any assumptions made regarding the stress distribution or effective stressed region should be documented. This may arise, for example, in calculating the shear force (or normalized shear stress) demand in concrete shear walls or floor diaphragms.

To the extent that reported deformation (including rotations or strain) demands are sensitive to assumptions used in their calculation, these assumptions should be clearly stated. In particular, the gauge lengths over which strain demands are evaluated should be reported and checked for consistency with the specified acceptance criteria.

In general, the force and deformation demands should be evaluated at their peak point during the response history analysis. Any deviations from this, including any integration or averaging of values over multiple time steps, should be noted and justified.

4.2.4 Floor Diaphragms

Model floor diaphragms to simulate the distribution of inertial forces to the vertical elements of the seismic-force-resisting system as well as transfer forces acting between these elements. In general, model diaphragms with finite elements using stiffness parameters based on the anticipated level of cracking in the concrete or concrete-filled steel deck floor system.

Establish diaphragm chord and drag forces in a manner consistent with the floor characteristics, geometry, and well-established principles of structural mechanics. Consider shear, axial, and bending stresses in diaphragms. Evaluate the dissipation or transfer of edge (chord) forces combined with other forces in the diaphragm at (a) diaphragm discontinuities, such as openings and re-entrant corners, and (b) around the podium level diaphragm and other levels where significant discontinuities exist in vertical elements of the seismic-force-resisting system.

Where diaphragms are designed to remain essentially elastic, they may be modeled using elastic finite elements with the effective stiffness values specified in Section 4.6.3. Construct the finite-element mesh with sufficient refinement to model the distribution of stresses within the diaphragm and transfers into chords, collectors, intersecting walls, and other members.

Diaphragms consisting of concrete slabs or concrete-filled metal decks may be modeled as rigid in-plane elements where:

1. There are no significant changes or discontinuities in the vertical elements of the gravity or seismic-force-resisting system above and below the diaphragm;
2. There are no re-entrant corners, large openings, or other horizontal irregularities in the diaphragm as defined in ASCE 7 Table 12.3.1; and,
3. The horizontal span-to-depth ratio of the diaphragm is less than 3.

Commentary: *Modeling of floor diaphragms as rigid in-plane elements may result in unrealistically large transfer forces at levels having significant discontinuities in vertical elements of the seismic-force-resisting system. Such levels include the podium, where shear forces from the superstructure transfer through the podium diaphragms to basement walls,*

and other setback levels. More realistic estimates of the transfer forces at such discontinuities can be obtained by modeling diaphragm flexibility at the level of the discontinuity and, perhaps, for a few levels above and below the discontinuity level. To adequately model diaphragm flexibility, the finite-element mesh will typically need to have at least three to five elements within each bay, although a finer mesh may be needed in transfer regions with high stress gradients. Moehle et al. (2016) provides further information on diaphragm design and modeling.

At podium levels (see Figure 4-1), it is particularly important to model the interaction among stiff vertical elements, the diaphragms, and the basement walls. The so-called “backstay effect” can result in very large transfer forces and may produce a drastic change in the distribution of shear force and overturning moment below the podium-level diaphragm. The backstay effect will depend strongly on the in-plane stiffness and strength of the diaphragm and its supporting elements. Realizing that these stiffness values depend on the extent of cracking, and that such extent is difficult to accurately calculate, it might be necessary to make bounding assumptions on stiffness properties to bracket the forces for which the various components of the podium structure should be designed. Appendix A of ATC 72 (2010) and Moehle et al. (2016) provide further discussion and guidance on design and modeling considerations to address the backstay effect.

4.2.5 Seismic Mass, Torsion, and Expected Gravity Loads

Determine the seismic mass based on the effective seismic weight of the building, including the dead load and other loads, as specified in ASCE 7 Section 12.7. Distribute the mass within the building plan to represent the translational and torsional inertial effects. Include inherent eccentricities resulting from the distribution of mass and stiffness. Where vertical ground motions are included in the analysis, include the vertical component of mass with sufficient horizontal distribution to compute the important vertical modes of response.

Include the seismic mass of the entire building in the model, including both the superstructure and below-grade structure. Exceptions to this may apply:

1. In response spectrum analyses, where inclusion of the below-grade mass will artificially inflate calculation of the minimum required base shear and resulting forces in the superstructure; and,
2. In response history analyses where it can be demonstrated that the inertial mass below grade will either (i) not exert forces on the structural components that are modeled in the analysis or (ii) be incorporated through other means in determining required member forces that are consistent with the system behavior.

Model accidental torsion for nonlinear response history analysis only in buildings that are especially susceptible to torsional effects. Chapter 6 provides a recommended procedure.

Model the effects of expected gravity loads in the nonlinear analysis using the load combination $D + 0.5L$, where L is 80% of unreduced live loads that exceed 100 pounds-per-square-foot (4.79 kN/m²) and 40% of other unreduced live loads.

Commentary: *Definition of the seismic mass and effective seismic weight should generally follow the ASCE 7 requirements. In tall buildings, it is important to include properly the mass of walls, columns, and other vertical elements that can make up a significant portion of the structural mass. Allowance for nonstructural components, including architectural finishes, mechanical/electrical equipment, plumbing fixtures, and fixed cabinets, should consider the*

distribution of components across the floor plan and up the height of the building (considering the stacked layout of architectural layouts and services).

Although it has sometimes been the practice to exclude mass of the substructure from the structural analysis model, this can lead to underestimation of earthquake inertial forces in the below-grade structure and foundations. Therefore, it is generally required to include the entire mass of the below-grade structure in the model unless it can be demonstrated that either the substructure mass will not contribute forces into the substructure and foundation, or the forces induced by the mass below grade are otherwise accounted for in the design. In general, there are four possible mechanisms to resist inertial forces of below-grade mass: (1) passive soil-bearing pressures on basement walls, (2) side friction on basement walls, (3) friction below the foundation, and (4) shear resistance of drilled shafts, piles, or other deep foundation elements. The extent to which one or more of these will resist inertial loads depends primarily on the relative stiffness of each, which in turn depends on the site conditions, basement depth, and type of foundation (deep versus shallow). In cases with shallow foundations (e.g., mat foundations without piles), the primary resistance is likely to be due to friction below the foundation and side friction on basement walls. On the other hand, in cases with deep foundations, the deep foundations and side friction on the basement wall are likely to resist most of the inertial force from the superstructure and substructure. In any case, provisions should be made for resisting the inertial forces due to the below grade mass either in the nonlinear analysis model or through separate design checks.

Explicit modeling of accidental eccentricities is not required, except where the lateral system has little inherent torsional stiffness. See Chapter 6 for the recommended procedure to identify such buildings. When accidental eccentricities are included, it is necessary to perform multiple sets of analyses with the center-of-mass systematically moved away from its actual location by a distance equal to 5% of the diaphragm dimension parallel to the direction of the mass shift. It is only necessary to apply this mass shift in in one direction at a time.

4.2.6 Load Combinations

Chapters 5 and 6, respectively, specify load combinations for combining earthquake and gravity-load effects in acceptance evaluations. Rather than performing multiple nonlinear analyses with varying amounts of dead and live loads, it is acceptable to represent dead and live load using expected values in the analysis, as defined in Section 4.2.5.

Commentary: *Superposition does not apply where there are nonlinear geometric (e.g., P-Delta) or material effects. Moreover, material nonlinear (inelastic) analysis is load-path dependent. Therefore, the results for all analyses (material linear with P-Delta effects, or material nonlinear) should be run under the combined gravity- and lateral-load effects. The gravity load applied in the analysis should include the effective seismic weight (Section 4.2.5) and a portion of the expected live load, as indicated in Chapters 5 and 6.*

4.2.7 Equivalent Viscous Damping

A small amount of equivalent viscous damping may be included in linear response spectrum analyses and in linear and nonlinear response history analyses to account for energy dissipation that is not otherwise represented by the analysis model. Unless evidence is provided to justify

larger values, effective additional modal or viscous damping for the primary modes of response under SLE shaking shall not exceed the fraction of critical damping given by Equation (4-1):

$$\zeta_{critical} = \frac{0.36}{\sqrt{H}} \leq 0.05 \quad (4-1)$$

where H is the height of the roof, excluding mechanical penthouses, above the grade plane, in feet. For height H in meters, change coefficient 0.36 to 0.20. For MCE_R shaking, unless evidence is provided to justify larger values, effective additional modal or viscous damping for the primary modes of response shall not exceed the fraction of critical damping given by Equation (4-1) except the value need not be taken less than 0.025.

Where viscous damping is explicitly modeled in the soil–foundation interface, conduct an analysis of the total viscous damping to determine whether the equivalent viscous damping applied through modal or Rayleigh models should be reduced.

Commentary: *Damping effects of structural members, soil–foundation interaction, and nonstructural components that are not otherwise modeled in the analysis can be incorporated through equivalent viscous damping. The amount of viscous damping should be adjusted based on specific features of the building design. The equivalent viscous damping can be represented through modal damping, including the fundamental mode up through higher modes with periods greater than 0.2 times the fundamental period. Alternatively, mass and stiffness proportional Rayleigh damping may be used, where checks are made to ensure that modes of response significant to the calculated demand parameters are not overdamped. ATC 72 (2010) Chapter 2 provides a discussion and recommendations for modeling viscous damping in analytical models of tall building structures. Both ATC 72 and more recent research publications [e.g., Cruz and Miranda (2016) and Bernal et al. (2015)] provide evidence from measured building data at low-to-moderate response amplitudes that damping in tall buildings is less than that in low-rise buildings. Reasons for the lower damping are mainly attributed to smaller relative damping contributions from foundations in tall buildings. Hence, as illustrated in Figure 4-2, viscous damping for SLE shaking is limited according to Equation (4-1). In the judgment of the authors of this Guideline, a modest amount of additional damping is acceptable at MCE_R shaking at longer periods to account for non-modeled radiation damping and non-modeled inelastic response in elements such as transfer diaphragms and nonstructural components.*

If soil–foundation damping is modeled explicitly in the analysis, then low-amplitude shaking (below the elastic limit) can be applied to establish the total amount of viscous damping in the structure. The total amount of viscous damping should be evaluated based on measured damping in buildings [see ATC 72 (2010)].

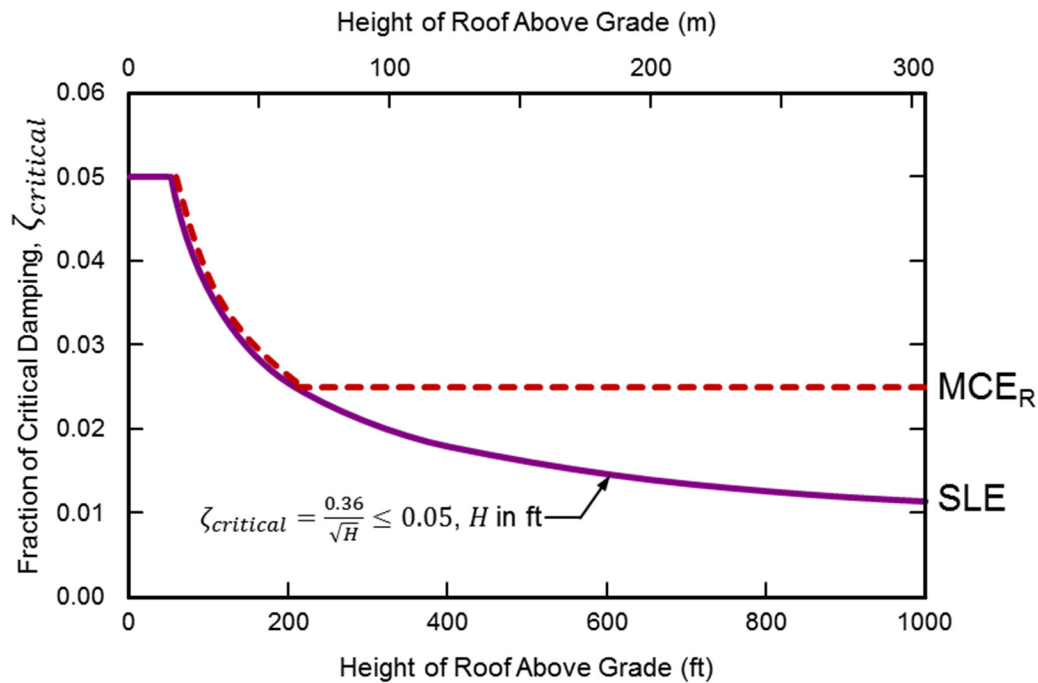

Figure 4-2 Equivalent viscous damping versus building height based on Equation (4-1).

4.2.8 P-Delta Effects

Include P-Delta effects in nonlinear analysis, regardless of whether elastic analysis design checks indicate that such effects are important. The P-Delta effects should include the destabilizing gravity loads for the entire building, where the gravity loads are spatially distributed to capture both building translation and twist.

Commentary: The widely used elastic stability coefficient ($\theta = P\delta/Vh$) is often an insufficient indicator of the importance of P-Delta effects in the inelastic range. P-Delta effects may become an overriding consideration when strength deterioration sets in and the tangent stiffness of the story shear force versus story drift relationship approaches zero or becomes negative. When this happens, the story drift ratchets, that is, it increases in one direction without the benefit of a full reversal that otherwise would straighten out the story. For this reason, and many others, realistic modeling of component deterioration and post-yield stiffness are critical aspects of modeling. The potential for dynamic instability is relatively high in flexible moment frame structures and in braced frames and shear wall structures in which one or several of the lower stories deform in a shear mode and the tributary gravity loads are large such that P-Delta will lead to a significant amplification of story drift demands. ATC 72 (2010) Chapter 2 provides detailed information on P-Delta effects and why and when the effects become an important consideration in inelastic structural response.

Where the gravity columns are not explicitly included in the analysis model, provision should be made through the addition of leaning columns or other techniques to simulate the destabilizing P-Delta effects of gravity loads acting on the gravity columns. In such cases,

the leaning columns should be located to correctly model P-Delta effects associated with building translation and twist.

4.2.9 Vertical Ground Motion Effects

Perform explicit simulation of vertical earthquake response where there are discontinuities in the vertical-load-carrying elements. In these cases, include vertical masses (based on the effective seismic weight) with sufficient model discretization to represent the primary vertical modes of vibration in the analysis model used to simulate vertical response.

Commentary: *For most structural elements, the effect of vertical response is only of moderate influence, given that gravity-load-resisting elements have substantial reserve capacity associated with the dead- and live-load combinations specified by the building code. In typical cases, the effect of vertical response can be approximated through use of the term $0.2S_{MS}D$ incorporated in the acceptance evaluations of Chapter 6. However, where significant discontinuities occur in the vertical-load-resisting system (e.g., where building columns supporting several stories and significant floor area terminate on transfer girders, or major load-bearing walls terminate on columns), vertical response can significantly amplify demands. In such cases, these Guidelines recommend explicit simulation of vertical response. It is not the intent to require such analyses where relatively minor columns supporting only a few stories or small floor area are transferred.*

4.3 LINEAR ANALYSIS (SERVICE LEVEL)

Linear analysis is appropriate for evaluating SLE criteria (Chapter 5) or other situations where the acceptance criteria are intended to ensure that the structure remains essentially elastic. Linear analysis is also required for Design Earthquake (DE) evaluations in accordance with ASCE 7 Chapter 12, when such evaluations are required. For either purpose, perform linear analysis using either response spectrum analysis or response history analysis methods.

Other sections of this chapter specify modeling parameters for linear analysis.

Commentary: *Modeling requirements for linear analysis are similar to those used for conventional seismic design using linear analysis. However, for evaluation of SLE performance, the structural model should include members of the gravity-load-resisting system that are generally not included in the analysis model for conventional prescriptive design. In addition, the effective stiffness values for concrete and other materials may be larger than typically used for prescriptive design to reflect the limited cracking under the smaller ground motion intensities and drift limits imposed at the SLE.*

4.3.1 Response Spectrum Analysis

Conduct linear response spectrum analyses using two horizontal components of motion represented by the linear spectra for the hazard level of interest. Include sufficient modes in the analysis to include participation of at least 90% of the building mass for each principal horizontal direction of response. Combine modal response using the Complete Quadratic Combination (CQC) method.

Commentary: *The response quantities obtained from linear response spectrum analysis are assumed to represent mean values. When used to evaluate SLE performance, linear*

response spectrum analysis is not modified by response modification coefficients, R , or overstrength factors, Ω_0 , nor should the results be scaled to minimum base-shear criteria. Rather, the displacement and strength demands computed from the linear response spectrum analysis under the SLE spectrum are compared directly with the acceptance criteria of Chapter 5.

4.3.2 Response History Analysis

When used, conduct linear response history analysis using two horizontal components of input ground motions at the hazard level of interest. Select and modify ground motions in accordance with Chapter 3. Introduce ground motion at the base mat or top of pile caps, or through soil springs. Soil–foundation–structure interaction effects may be included as described in Section 4.5. Calculate average values of peak story drifts and member forces from the individual ground motion analyses for comparison with acceptance criteria.

Commentary: *Response spectrum analysis is usually preferred over linear response history analysis due to its computational efficiency and simplified data reporting. The linear response history analysis procedure specified in ASCE 7 has been specifically formulated to produce results that are similar to those obtained from response spectrum analysis, though small differences may occur due to variability in the ground motions relative to the target spectrum, as well as modal phasing that response spectrum analysis can only approximate.*

Linear response history analysis is recently experiencing some popularity, however, because this technique can preserve the signs of response quantities and also because of the computational efficiency available in today's software and hardware. Linear response history analysis can also be used as a benchmark for evaluation of nonlinear response history analysis results.

4.4 NONLINEAR ANALYSIS (SERVICE OR MCE_R LEVEL)

Nonlinear response history analysis is necessary to evaluate earthquake demands when the structure deforms significantly beyond the elastic range. Nonlinear response history analysis is required for MCE_R evaluation, as presented in Chapter 6. Nonlinear response history analysis may be used for SLE evaluation, as presented in Chapter 5.

Perform modeling and analysis in accordance with the requirements of this chapter. Select and modify input ground motions in accordance with the requirements of Chapter 3. Model foundations and soil–foundation–structure interaction effects as outlined in Section 4.5. Introduce ground motions at the base mat or top of pile caps, or through soil springs. Section 4.6 specifies element properties and expected values of strength and effective stiffness for use in analysis.

Commentary: *The modeling requirements for nonlinear analysis generally follow those published in the other supporting documents cited in Section 4.1 along with other references cited in this chapter.*

4.4.1 Important Modeling Parameters

Use hysteretic models that adequately account for all important phenomena affecting response and demand simulation at response amplitudes for the hazard level of interest. Where models

do not reliably represent strength and stiffness degradation under the imposed deformations and cyclic loading, then either (a) adjust the model parameters to conservatively account for the expected deterioration under cyclic loading, or (b) modify the acceptance criteria to limit the range of behavior to response levels that the analysis model can reliably represent.

Commentary: *Hysteretic models based solely on monotonic or cyclic envelopes without stiffness and strength deterioration may be inadequate to accurately simulate response at levels that are otherwise within the peak story drift acceptance criteria for the MCE_R evaluation. Idealized structural component response can be described by multi-linear diagrams of the types illustrated in Figure 4-3, referred to herein as the monotonic backbone curve and the first-cyclic envelope curve. Figure 4-4 shows an example of the derivation of these curves from test data. The monotonic backbone curve represents the theoretical component force-deformation behavior if the component is pushed in one direction, without cycling, to failure. The first-cycle envelope curve represents the envelope of cyclic response data, which often are determined from symmetric cyclic loading tests of structural components. As shown in Figure 4-3, the first-cyclic envelope is similar to the ASCE 41 response model parameters. These generally provide a somewhat conservative estimate of response because they can over-estimate the effects of degradation. On the other hand, they can result in under-estimates of peak strength demands on force-controlled actions. Researchers are continuing to develop more realistic models and parameters that can simulate the strength and stiffness degradation applicable to a specific loading history. The definitions of monotonic backbone and first-cyclic envelope curves help enable the calibration of more advanced models that naturally degrade under cyclic loading (e.g., ATC 72-1, 2010; NIST, 2017a; NIST, 2017d). Acceptable hysteretic models should be verified against experimental test data, although it might be acceptable to validate hysteretic component models by a combination of detailed continuum finite-element analyses along with material and component test data.*

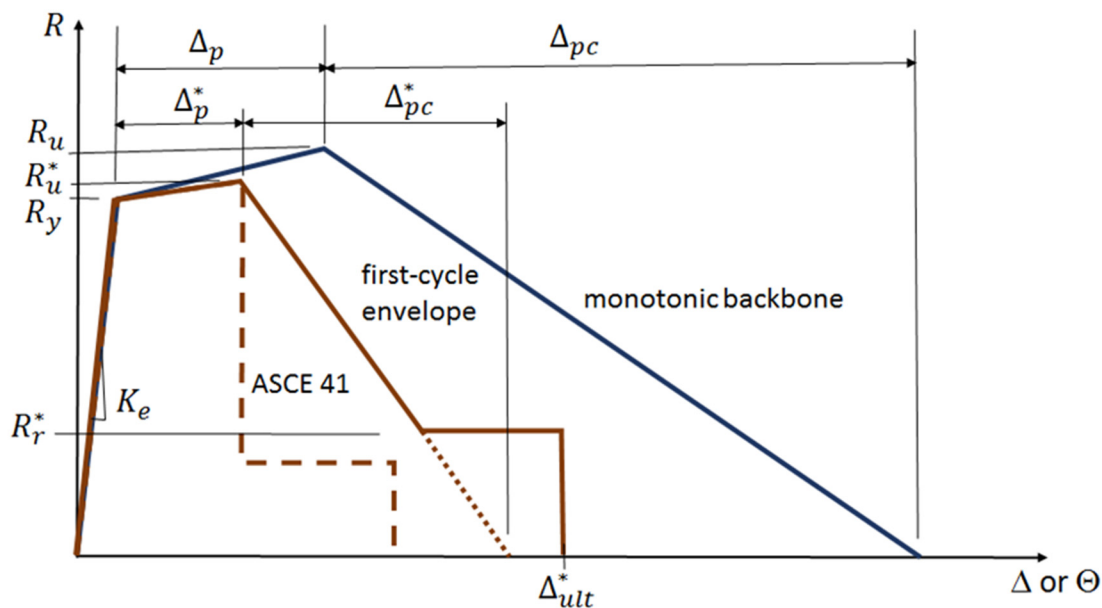

Figure 4-3 Idealized component response curves and parameters.

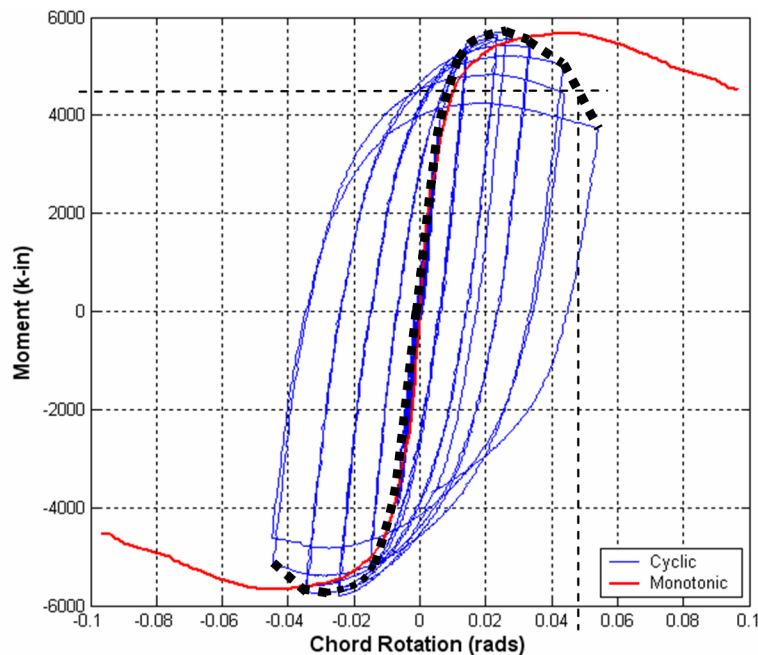

Figure 4-4 Typical monotonic backbone curve (red curve), cycle test data (blue curve), and first-cycle envelope curve (heavy broken black curve) (Tremblay *et al.*, 1997).

Key parameters for the idealized response curves are:

K_e	=	elastic (secant) stiffness up to the yield point
R	=	characteristic stress resultant (force or moment) in a structural component
R_u	=	peak strength of the monotonic backbone
R_u^*	=	peak strength of the cyclic backbone
R_y	=	effective yield strength of the component
R_r^*	=	residual strength of the cyclic backbone
Δ or Θ	=	characteristic deformation (displacement or rotation) in a structural component
Δ_p	=	plastic deformation up to the peak strength of the monotonic backbone
Δ_p^*	=	plastic deformation up to the peak strength of the cyclic backbone
Δ_{pc}	=	plastic deformation of the descending portion of the monotonic backbone
Δ_{pc}^*	=	plastic deformation of the descending portion of the cyclic backbone
Δ_{ult}^*	=	ultimate deformation capacity at which point characteristic strength of the component is lost or where the component loses the resistance to resist vertical gravity loads
first-cycle envelope	=	idealized envelope of component response under symmetric cyclic loading
monotonic backbone	=	idealized component response under monotonic loading
ASCE 41	=	idealized component response under cyclic loading as specified in ASCE 41

4.4.2 Methods for Establishing Component Properties

Establish component monotonic backbone curve and cyclic deterioration characteristics from a combination of physical test data and analytical approaches that have been benchmarked to physical test data. Consider the sources of deterioration indicated in Table 4-1 unless precluded by detailing and/or capacity design.

Table 4-1 Sources of deterioration.

Structural Steel	Reinforced Concrete
Compressive buckling of members	Concrete cracking, crushing, and spalling
Shear buckling of webs and plates	Rebar yielding, buckling, and fracture
Lateral torsional buckling of members	Rebar bond slip and anchorage failure
Local buckling of flanges or webs	Shear friction sliding and failure
Yielding and fracture of base metal	Concrete dilation
Yielding and fracture of weldments	Confinement steel yielding and failure
Bolt slippage, bearing, and fracture	

Commentary: Analysis models for overall structural system response can range from concentrated hinge or spring models, to fiber-type beam-column or wall models, to detailed continuum finite-element models. All models require some aspect of phenomenological calibration to physical test data, either at the material, subcomponent, or component level. Section 4.6 outlines the types of models that are best suited for various structural components, based on the capabilities of analysis software that is generally available for structural engineering design practice. The provisions and commentary to Section 4.6 also point to references that can serve as resources for establishing component model parameters. However, in the absence of a single source of comprehensive and consensus-based modeling criteria, designers will need to synthesize the best available information to meet their project requirements, considering the structural system, materials, and likely modes of deterioration.

4.4.3 Component Analytical Models

Establish the valid range of deformation capacities as (a) the corresponding ASCE 41 Collapse Prevention values for secondary elements for nonlinear analyses; (b) physical test data; or (c) analytical models validated by physical test data. When applicable, the ASCE 41 component force versus deformation models may be used as first-cycle envelope curves, with the exception that the decreasing resistance beyond the point of peak strength should not be as rapid as indicated in the ASCE 41 models. Alternatively, the modeling options presented in NIST (2017a) and ATC 72-1 (2010) may be employed.

Commentary: The rapid post-peak drop in resistance indicated in the ASCE-41 curves is not realistic (unless fracture occurs) and may cause numerical instabilities in the analysis process. In such cases, the slope of the post-peak degrading branch can be adjusted to have a less sudden drop off.

Do not use component models that do not account for post-peak strength deterioration or for cyclic deterioration for nonlinear analysis, unless appropriate limitations on the maximum deformation are specified. This implies that either (a) the analysis is continued, but without any strength or stiffness contribution from components that have exceeded their limit of reliability; or (b) the analysis should be considered invalid and terminated when component deformations reach their limit of reliability. Justify the choice of an appropriate component modeling option and of the basic hysteresis model used to represent the cyclic response of structural components in the analysis documentation.

Commentary: *Nonlinear component modeling can generally be characterized into one of the following three options, each of which has limitations and implications on their use (see Figure 4-5):*

Option 1 – Stiffness and Strength Degradation Model (Figure 4-5a): This option explicitly models the strength and stiffness deterioration that occurs under cyclic loading using an algorithm that evolves the response from the monotonic response to some deteriorated response that is a function of cyclic loading. Models in this category may include (a) detailed continuum finite-element models that can represent important modes of deterioration or (b) phenomenological concentrated hinge or fiber models with formulations capable of simulating deterioration. Using such models, pulse-like loading excursions will tend to follow a response close to the monotonic curve, whereas cyclic loading will naturally degrade the model from the monotonic curve. This is the preferred model option as it provides the most realistic response.

Option 2 – Degraded Backbone Model (Figure 4-5b): This option is used for models that simulate post-peak response but whose backbone response parameters do not automatically degrade under cyclic loading. These models typically use a backbone response curve that follows the first-cycle envelope curve. Such first-cycle envelope curves are given by ASCE 41 and other publications (NIST, 2017a; ATC 72, 2010).

Option 3 – Limit Point Cutoff Model (Figure 4-5c): This option uses a model that does not represent cyclic strength degradation, including post-peak strain softening (negative tangent stiffness). Where used, the ultimate deformation of the component should be limited to the point at which the model fails to accurately represent response. This limit can be established by the peak point in the component models in ASCE 41 or by other supporting data and information.

4.4.4 Residual Drift Demands

Construct models used for MCE_R analyses with hysteretic response curves that realistically simulate the cyclic unloading and reloading range of response. Confirm these attributes by comparing hysteretic response plots from analyses of representative structural components with test data or other supporting information. Include these comparisons in project documentation.

Commentary: *Research shows that calculated residual story drift has larger variability and is more sensitive to hysteretic unloading and reloading response than is peak transient drift (Appendix C, FEMA P58, 2012). P-Delta effects will also influence residual drifts. As a general check on the residual drift, it is suggested to compare the residual drifts determined from nonlinear analysis with those calculated by the simplified formula, based on peak transient drifts, in Appendix C of FEMA P58 (2010).*

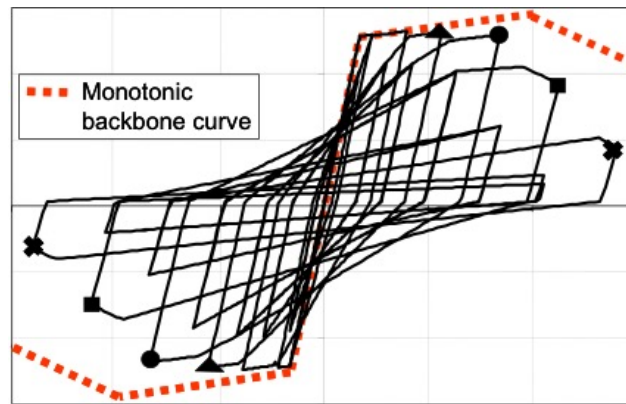

(a) Option 1 – Stiffness and Strength Degradation Model

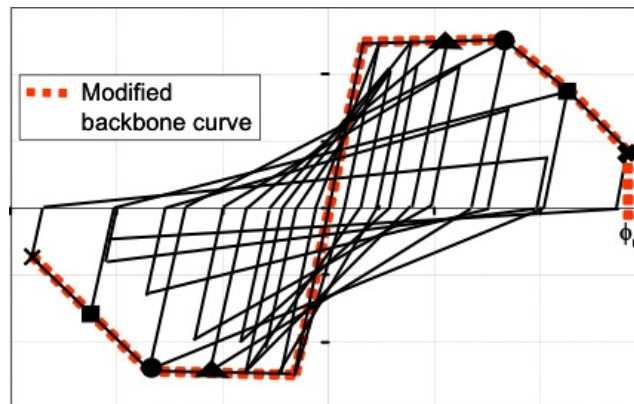

(b) Option 2 – Degraded Backbone Model

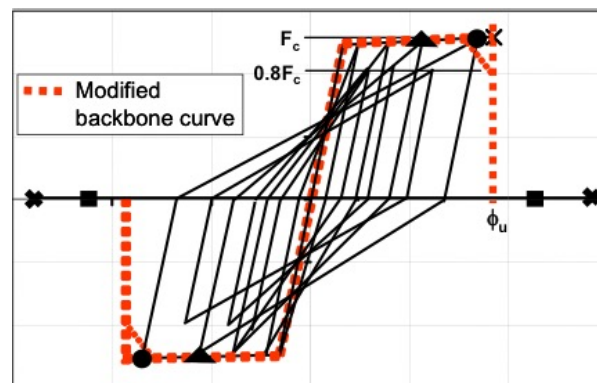

(c) Option 3 – Limit Point Cutoff Model

Figure 4-5 Illustration of analytical model options.

4.4.5 Ground Motion Duration

Where the MCE_R ground motion has significant contribution from large magnitude long-duration earthquakes, construct nonlinear models used for MCE_R analyses using hysteretic response curves that realistically simulate cyclic strength and stiffness deterioration.

Commentary: Research shows that ground motions with long durations can induce larger drifts and reduce the collapse capacity of buildings, relative to response under shorter-duration ground motions (Chandramohan et al., 2016; Raghunandan and Liel, 2013). Ground motion effects are typically of concern when the characteristic earthquakes have magnitudes larger than about $M7.5$. While there is no clear consensus on duration effects, suggested measures to check for duration effects include the following: (1) include significant duration as a consideration in characterizing earthquake ground motions and selecting input ground motions, and (2) perform sensitivity studies for analyses subjected to ground motions of different durations to help establish whether the structural system is sensitive to ground motion duration.

4.5 FOUNDATION MODELING AND SOIL–STRUCTURE INTERACTION

Model the foundation and soil–structure interaction effects in accordance with this section, including:

1. Soil–structure interaction effects in Section 4.5.1;
2. Subterranean structural components, including at the soil–foundation interface in Section 4.5.2;
3. Ground motion change from the free-field ground surface condition to the foundation level of the structure in Section 4.5.3; and
4. Analysis of seismic earth pressures in Section 4.5.4.

The recommendations in this section are equally applicable to response evaluations for SLE and MCE_R ground shaking.

4.5.1 Soil-Structure Interaction Effects

Explicit consideration of soil–structure interaction (SSI) effects in the structural model is optional in these Guidelines.

Commentary: These Guidelines encourage, but do not require, explicit foundation modeling and consideration of SSI for reasons of consistency with current practice and perceptions that such explicit consideration would significantly complicate the design process. However, SSI affects the seismic response of tall buildings in the following respects:

1. Flexibility and damping at the soil–foundation interface affect the seismic response of a building, relative to a fixed-base condition that neglects SSI. For tall buildings, the most significant effects are typically on the distributions of component demands, both vertically and horizontally, within the structure. For example, vertical soil springs under foundations can affect the transfer of forces to basement walls through the backstay effect. Other effects include lengthening of the effective fundamental period and modification of damping (generally increased), although these effects are typically modest for tall buildings.
2. Ground motion inputs at the foundation level are typically less than those computed for free-field conditions.

3. *Relative wall–soil displacements control horizontal pressures developed along basement walls, which in turn influence forces developed in below-grade floor diaphragms. SSI controls these relative displacements and wall pressures.*

Figure 4-6 depicts a tall building with subterranean levels. Figure 4-6(a) shows the structure and the free-field ground motion, u_g . Figure 4-6(b) shows a structural model extended to the foundation level, where it is fixed. Models of this type ignore SSI, which biases the computed structural response, and provides no rational means to assess seismic earth pressures on basement walls. The level of bias can be difficult to assess a priori, and may result either in over- or under-estimation of component demands. For these reasons, designers are encouraged to consider SSI effects when developing analytical models for seismic evaluation of tall buildings.

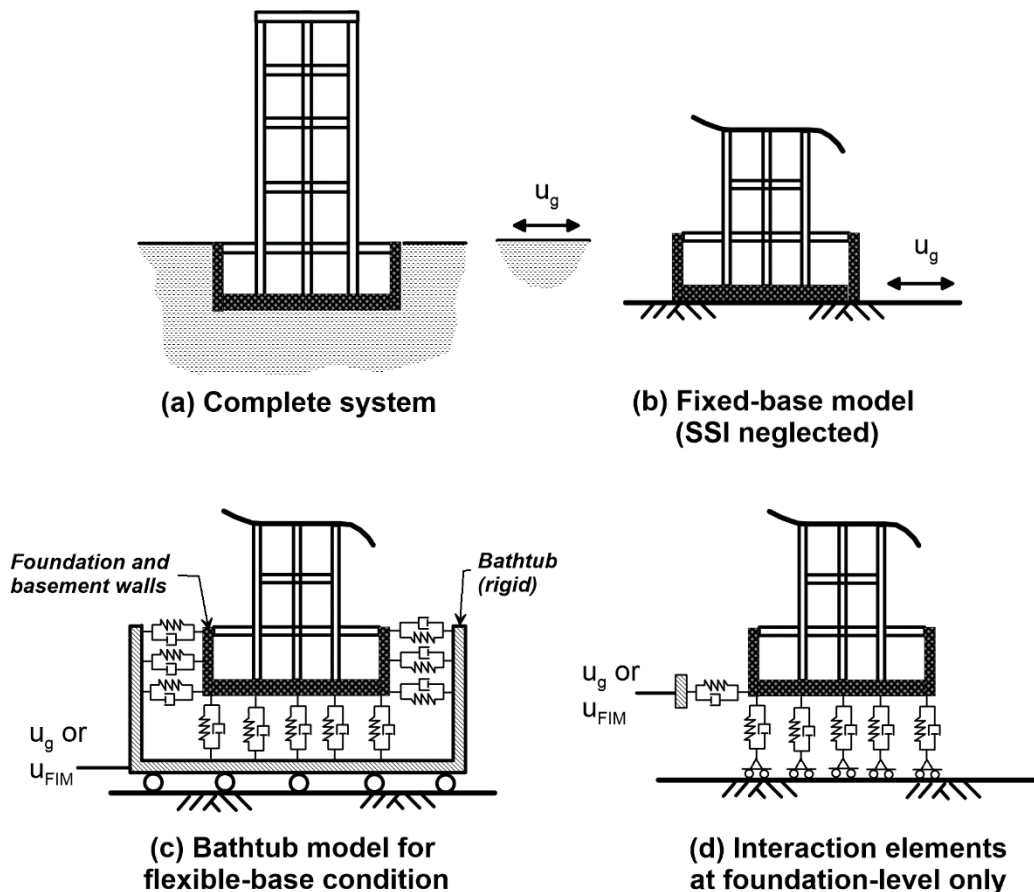

Figure 4-6 Schematic illustration of alternative models of buildings with basements.

Several modeling approaches allow explicit consideration of SSI effects. The most rigorous of these consider spatially variable ground motions around the structure due to wave propagation effects as driving the foundation and structural response [described as the ‘direct approach’ in NIST (2012)]. Such approaches are too complex for most projects and are not shown in Figure 4-6.

Figures 4-6(c)-(d) present two simplified approaches that represent many of the principal SSI effects while maintaining practicality given the capabilities of most current structural

engineering analysis software. Figure 4-6(c) shows the “bathtub model,” which includes elements to simulate soil–foundation interaction (shown with springs and dashpots) and allows for ground motion change from the free field (u_g) to the foundation (u_{FIM}). The bathtub model introduces one simplification relative to the complete system, which is depth-invariant ground motions. Figure 4-6(d) shows an option in which soil–foundation interaction elements are included at the foundation level only, which avoids the use of input motions applied to the ends of interaction elements along basement walls.

The bathtub model (Figure 4-6c) is a simplified representation of the structure–foundation–soil system. It was developed to avoid the need for multi-support excitation in response history analyses that incorporate SSI (most structural engineering software for such analyses do not allow for multi-support excitation). The bathtub model has been shown to accurately simulate most structural responses relative to more complete modeling that includes multi-support excitation, the principal exception being subterranean parameters such as soil pressures (Naeim et al., 2008).

The bathtub model applies the same ground motion to the ends of soil–foundation interaction elements at the foundation level and across the embedded depth of the structure. To apply the same ground motion at these depths requires the use of rigid elements (for the ends of interaction elements opposite the foundation), which can create numerical difficulties in some structural engineering software packages. An option that can be considered to overcome this problem is to use interaction elements at the foundation level only (Figure 4-6d). When interaction elements are used only at the foundation level, they should in aggregate reproduce the cumulative stiffness of the embedded foundation as given in NIST (2012) or similar documents. (This stiffness is higher than that of the base slab alone as a result of embedment effects.)

4.5.2 Modeling Subterranean Components

For all cases, construct the structural analysis model to extend down to the base of the structure, as shown in Figures 4-6a-d. Include subterranean levels in the structural model used for dynamic response analysis, including appropriate mass, stiffness, and strengths of the subterranean structural members including walls, columns, and slabs. Include in the subterranean mass that of the actual structural elements.

If SSI effects are to be considered, explicitly model the flexibility and (if desired) damping at the soil–foundation interface either using soil springs, springs combined with dashpots, or a continuum (finite-element or finite-difference) model of the soil–foundation–structure system. If a springs-only approach is used, the beneficial effects of radiation damping are not included in the model.

If SSI is considered (Figures 4-6c-d), apply seismic excitation using the foundation input motion (u_{FIM}), which is modified for kinematic interaction effects (see next section). As an alternative, the free-field motion (u_g) can be used, although this is less realistic and will increase structural demands at high frequencies.

Commentary: *Refer to NIST (2012) for guidance on the selection of appropriate foundation springs and dashpots for the base slab, basement walls, and piles (as applicable). Document in the Basis of Design and calculations how the effects of soil layering, foundation flexibility, and soil-limiting stresses are considered in the development of spring stiffness and capacities.*

Because SSI modeling remains optional in these Guidelines, analysts must decide if incorporating these effects is likely to change analysis results significantly. Foundation modeling is critical for structures with dual systems with uncoupled foundation systems, as shown schematically in Figure 4-7. In such cases, rocking of relatively stiff lateral-force-resisting systems imposes displacement demands on other parts of the structure that the analysis cannot properly simulate when SSI is neglected. Ignoring SSI for structures of this type has the potential of being unconservative. As shown in Figure 4-8, a condition for tall buildings with podiums that is conceptually similar is core walls supported on a different foundation system than that used to support outlying gravity columns or podium elements. Different amounts of rocking in the core walls and these other elements can lead to large diaphragm force transfers that are not correctly represented in fixed-base analyses.

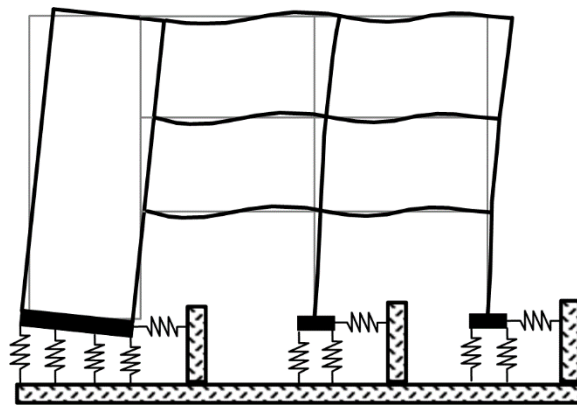

Figure 4-7 Dual-system wall-frame building structure with independent foundations supporting wall and columns.

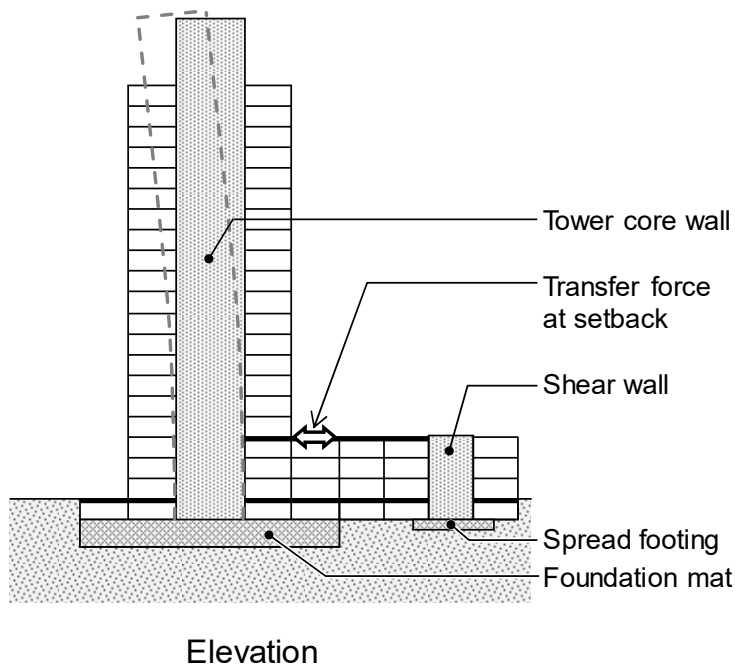

Figure 4-8 Core-wall tower with podium having separate foundation system.

NIST (2012) provides guidelines as to when SSI is likely to significantly affect the fundamental-mode response of buildings—specifically when $h/(V_s T) > 0.1$, where h is about 2/3 of the structure height, V_s is an appropriate soil–shear wave velocity, and T is the fixed-base building period. This condition is rarely satisfied for tall buildings. Nonetheless, studies have shown significant effects on vertical distributions of story drifts and story shears, which result in part from SSI influence on higher-mode responses [e.g., Naeim et al. (2008)].

4.5.3 Foundation-Level Ground Motions

Foundation-level ground motions are reduced from free-field ground motions principally as a result of embedment and base-slab-averaging effects. Ground motions modified for these effects, but without consideration of foundation/structure inertia, are termed *Foundation Input Motions* (e.g., u_{FIM} in Figure 4-6).

If SSI effects are considered, modify free-field ground motions u_g to foundation input motions u_{FIM} , which are applied at the ends of foundation springs. Alternatively, perform continuum-type modeling of the foundation–soil system, which implicitly accounts for embedment effects.

As recommended in ASCE 7-16 Chapter 19, consideration of reduced ground motions from embedment and base-slab averaging is not permitted without also considering the flexibility and damping at the foundation–soil interface, as described in the previous section.

Commentary: *Refer to NIST (2012) for guidance on modeling the effects of base-slab averaging and embedment on input motions. Document in the Basis of Design and calculations the selection of model parameters for each effect. If site-specific ground response analyses are performed (Section 3.4), the ratio of the computed ground motion at the foundation depth to u_g can be used in lieu of the embedment models in NIST (2012).*

If the structural analysis software allows for multi-support excitation, use ground response analysis to compute depth-variable input motions to be applied at the end of basement wall springs. If base-slab-averaging effects are considered in the analysis, the transfer function for base-slab averaging should be applied to each of the depth-variable motions (i.e., for each height along the wall, including at the base-slab level).

Continuum models for structure–foundation–soil systems compute site response through shallow soil layers, and provide for the embedment effect implicitly. These models are generally unable to model base-slab-averaging effects, because they do not consider horizontally spatially-variable ground motions. As noted in Section 3.4, such models cannot reliably compute site response at periods in excess of the soil column period. Refer to Section 3.4 for commentary on addressing this long-period problem.

ASCE 7-16 Chapter 19 allows only 75% of the ground motion reduction computed using NIST (2012) procedures, as a result of the uncertainty regarding the applicability of SSI models for yielding structures. Limit the ground motion reductions as recommended by ASCE 7-16 unless the peer reviewer(s) approve the full reductions provided by NIST (2012).

4.5.4 Seismic Pressures on Basement Walls

Prior to seismic loading, basement walls are subject to gravity-induced lateral earth pressures that are sensitive to the amount of displacement the wall undergoes. Apply at-rest earth pressures when the wall is restrained against displacement and active earth pressures when the wall is allowed to relax away from the retained soil.

Seismic earth pressures result from relative wall–soil displacements induced by earthquake shaking. These earth pressures cyclically reduce and increase the pre-earthquake pressures, and as such are sometimes termed a seismic increment to the lateral earth pressure. Evaluate the positive (increased) seismic earth pressure increment using analytical methods that appropriately consider relative wall-soil displacement as the driving mechanism.

Commentary: *Two processes can lead to significant seismic earth pressures:*

1. *When basement walls are part of the lateral-force-resisting system at the subterranean level, they experience shear and overturning demands associated with the structural response, which in turn displace the walls relative to surrounding soil; and,*
2. *When basement walls are tall relative to seismic wavelengths containing significant energy, differential wall–soil displacements develop as a function of depth.*

The first process is associated with the structural inertia and can be accounted for in the structural model by including appropriate soil–foundation springs elements (or similar from continuum models) as described in Section 4.5.1. The resultant of the seismic earth pressure increment at a particular depth is approximately the product of spring deflection and stiffness.

The second process is principally dependent on the ratio of seismic wavelength to wall height (λ/H), and is generally negligible for $\lambda/H > 10$. These seismic earth pressures are referred to as kinematic and do not consider the inertia of the wall system or externally applied loads. Brandenburg et al. (2015) provide a simplified framework for analysis of kinematic earth pressures in which the walls are taken as rigid and the soils as uniform with depth. The same approach can be applied for cases of non-uniform soil or flexible walls (e.g., Brandenburg et al., 2017a,b); consideration of such effects is advisable when seismic earth pressures from this method are large (e.g., for $\lambda/H < \sim 8$).

Classical methods in which seismic earth pressures are related to ground acceleration (e.g., the Mononobe-Okabe method and its variants) have been shown to over-predict earth pressures measured in centrifuge tests on walls embedded in soil [e.g., Al Atik and Sitar, (2010) and Mikola et al. (2016)] and to under-predict earth pressures computed for walls founded on a rigid base and retaining an elastic soil medium [e.g., Ostadan [2005] and Vrettos et al. (2016)]. These divergent results occur because the classical methods do not appropriately consider the role of relative wall–soil displacement. Such methods are no longer recommended for use.

4.6 STRUCTURAL MODELING PARAMETERS

Develop the structural analysis model based on expected properties considering the anticipated level of response and damage.

Commentary: *The structural analysis model is intended to provide an unbiased, best estimate of expected response of the building when subjected to earthquake ground motion. For this reason, the structural analysis model should be developed based on expected material and member stiffnesses, strengths, and deformation capacities, rather than values that have been adjusted to achieve a “conservative” estimate of response.*

4.6.1 Expected Material Strengths

Define expected material strengths based on applicable data for the project or from projects using similar materials and construction.

Where applicable project-specific data are not available, it is permissible to use the expected strengths of Table 4-2.

Table 4-2 Expected material strengths.

Material	Expected strength	
	Expected Yield Strength, f_{ye} , psi	Expected Ultimate Strength, f_{ue} , psi
Reinforcing Steel		
A615 Grade 60	70,000	106,000
A615 Grade 75	82,000	114,000
A706 Grade 60	69,000	95,000
A706 Grade 80	85,000	112,000
Structural Steel***		
Hot-rolled structural shapes and bars		
ASTM A36/A36M	1.5 f_y *	1.2 f_u **
ASTM A572/A572M Grade 50	1.1 f_y	1.1 f_u
ASTM A913/A913M Grade 50, 60, 65 or 70	1.1 f_y	1.1 f_u
ASTM A992/A992M	1.1 f_y	1.1 f_u
Plates		
ASTM A36/A36M	1.3 f_y	1.2 f_u
ASTM A572/A572M Grade 50, 55	1.1 f_y	1.2 f_u
Concrete	$f'_{ce} = 1.3f'_c$ †	

* f_y is used to designate the specified (nominal) yield strength of steel materials in this Guideline. It is equivalent to f_y or f_{yt} used in ACI 318 and F_y used in AISC (2006) standards.

** f_u is used to designate the specified (nominal) ultimate strength of steel materials in this Guideline. It is equivalent to F_u used in AISC (2006) standards.

***For steel materials not listed, refer to Table A3.1 of ANSI/AISC 341-16

† f'_c = specified compressive strength. Expected strength f'_{ce} is strength expected at approximately one year or longer. Note that the multiplier on f'_c may be smaller for high-strength concrete, and can also be affected by (1) use of fly ash and other additives, and/or (2) local aggregates.

Commentary: Tabulated steel properties for Grades 60 and 75 reinforcement are from Bournonville et al. (2004). Properties for Grade 80 are from Overby et al. (2015). The factor 1.3 applied to f'_c is based on experience with concrete mixtures having low to moderate compressive strengths and can vary depending on the factors noted. Where estimates of expected strength are especially critical in evaluating performance, project-specific data or data from projects using similar materials should be used. The values for structural steel are from Table A3.1 of ANSI/AISC 341-16.

4.6.2 Expected Component Strengths

Determine expected component strengths R_{ne} , for defining the modeling parameters for analysis as mean measured values from tests of specimens using details and materials that are representative of those used in the structure.

Alternatively, for structural concrete members, define expected section strengths using the nominal strength provisions of ACI 318, with f'_{ce} substituted for f'_c and f_{ye} substituted for f_y or f_{yt} , except as noted below in Section 4.6.5. For structural steel members, define expected section and member strengths using the nominal strength provisions of ANSI/AISC 360-16, with f_{ye} substituted for f_y and f_{ue} substituted for f_{yu} .

***Commentary:** The calculation of expected strengths based on the nominal strength equations and expected material properties follows the accepted practice of ASCE 41-17, ASCE 7-16 (Chapter 16), and other standards. However, there are instances, some of which are described in this section, where the effective strengths should be adjusted to correct for biases in the nominal strength equations.*

4.6.3 Effective Member Stiffness

Steel members and components: Model the elastic (initial) stiffness of steel members and components using full cross-sectional properties and the elastic modulus of steel [$E_s = 29,000$ ksi (200,000 MPa)].

Reinforced concrete components: In lieu of detailed justification, use the values in Table 4-3 for the effective stiffness of reinforced concrete members and components, along with component-specific guidance in subsections of Section 4.6.5.

Table 4-3 Reinforced concrete effective stiffness values.

Component	Service-Level Linear Models			MCE _R -Level Nonlinear Models		
	Axial	Flexural	Shear	Axial	Flexural	Shear
Structural walls ¹ (in-plane)	$1.0E_cA_g$	$0.75E_cI_g$	$0.4E_cA_g$	$1.0E_cA_g$	$0.35E_cI_g$	$0.2E_cA_g$
Structural walls (out-of-plane)	--	$0.25E_cI_g$	--	--	$0.25E_cI_g$	--
Basement walls (in-plane)	$1.0E_cA_g$	$1.0E_cI_g$	$0.4E_cA_g$	$1.0E_cA_g$	$0.8E_cI_g$	$0.2E_cA_g$
Basement walls (out-of-plane)	--	$0.25E_cI_g$	--	--	$0.25E_cI_g$	--
Coupling beams with conventional or diagonal reinforcement	$1.0E_cA_g$	$0.07\left(\frac{\ell}{h}\right)E_cI_g$ $\leq 0.3E_cI_g$	$0.4E_cA_g$	$1.0E_cA_g$	$0.07\left(\frac{\ell}{h}\right)E_cI_g$ $\leq 0.3E_cI_g$	$0.4E_cA_g$
Composite steel / reinforced concrete coupling beams	$1.0(EA)_{trans}$	$0.07\left(\frac{\ell}{h}\right)(EI)_{trans}$	$1.0E_sA_{sw}$	$1.0(EA)_{trans}$	$0.07\left(\frac{\ell}{h}\right)(EI)_{trans}$	$1.0E_sA_{sw}$
Non-PT transfer diaphragms (in-plane only) ³	$0.5E_cA_g$	$0.5E_cI_g$	$0.4 E_cA_g$	$0.25E_cA_g$	$0.25E_cI_g$	$0.1E_cA_g$
PT transfer diaphragms (in-plane only) ³	$0.8E_cA_g$	$0.8E_cI_g$	$0.4E_cA_g$	$0.5E_cA_g$	$0.5 E_cI_g$	$0.2E_cA_g$
Beams	$1.0E_cA_g$	$0.5E_cI_g$	$0.4E_cA_g$	$1.0E_cA_g$	$0.3E_cI_g$	$0.4E_cA_g$
Columns	$1.0E_cA_g$	$0.7 E_cI_g$	$0.4E_cA_g$	$1.0E_cA_g$	$0.7 E_cI_g$	$0.4E_cA_g$
Mat (in-plane)	$0.8E_cA_g$	$0.8E_cI_g$	$0.8E_cA_g$	$0.5E_cA_g$	$0.5 E_cI_g$	$0.5E_cA_g$
Mat ⁴ (out-of-plane)	--	$0.8E_cI_g$	--	--	$0.5E_cI_g$	--

¹Values are relevant where walls are modeled as line elements. Where walls are modeled using fiber elements, the model should automatically account for cracking of concrete and the associated effects on member stiffness.

² $(EI)_{trans}$ is intended to represent the flexural rigidity of the cracked transformed section. It is acceptable to calculate the transformed section properties based on structural mechanics or to use $(EI)_{trans} = E_cI_g/5 + E_sI_s$ per ACI 318.

³ Specified stiffness values for diaphragms are intended to represent expected values. Alternative values may be suitable where bounding analyses are used to estimate bounds of force transfers at major transfer levels. For diaphragms that are not associated with major force transfers, common practice is to model the diaphragm as being rigid in its plane. Flexural rigidity of diaphragms out of plane is usually relatively low and is commonly ignored. The exception is where the diaphragm acts as a framing element to engage gravity columns as outrigger elements, in which case out-of-plane modeling may be required.

⁴ Specified stiffness values for mat foundations pertain to the general condition of the mat. Where the walls or other vertical members impose sufficiently large forces, including local force reversals across stacked wall openings, the stiffness values may need to be reduced.

Commentary: *Tabulated effective stiffness values are intended to represent effective stiffness for loading near the onset of material yielding. Where expected stress levels are less than yield, it may be justified to increase the effective stiffness values. Where inelastic structural analysis models are used, the tabulated effective stiffness values can be acceptable as the effective linear branch of the inelastic model.*

For structural walls, common practice for nonlinear analysis is to use fiber models to represent axial and bending responses, with shear response represented by a linear stiffness. In such cases, the fiber model is used directly to represent axial and flexural stiffness, with the tabulated values not used. The effective shear stiffness would still apply if shear is modeled by a linear spring.

For coupling beams, the effective stiffness values are based on a review of data and analytical solutions of Naish et al. (2013), Son Vu et al. (2014), and Motter et al. (2017), adjusted to account for stiffening effects associated with test specimen scale and presence of the floor diaphragm. Values are intended to be suitable for typical values of beam shear; beams with higher reinforcement ratios tend to be stiffer than typical beams. The effective stiffness values are intended for use in analysis models that explicitly model both flexural and shear deformations; the effective flexural stiffnesses should be increased where shear deformations are modeled as rigid.

4.6.4 Structural Steel Components

In lieu of calibration to test data, model the parameters for steel components with concentrated hinge/spring models defined as described in Sections 4.6.4.1 through 4.6.4.8.

Commentary: *As described in Section 4.4.3, concentrated hinge models that simulate both cyclic strength and stiffness degradation may be defined based on the monotonic backbone curve and checked to ensure that they can produce a response representative of the first-cycle envelope curve (Figure 4-5a) when subjected to a cyclic loading protocol. Otherwise, where cyclic strength and stiffness degradation are not simulated, the models should be defined based on the first-cycle envelope curve.*

4.6.4.1 Steel beams in bending

Determine the moment-rotation response using parameters in NIST (2017b) or ASCE 41.

Commentary: *NIST (2017a) provides parameters for establishing both the monotonic backbone and first-cycle envelope curves for steel beams that generally conform to the design requirements for Special Moment Frames with fully restrained connections in AISC 341. ASCE 41 provides parameters, based on the first-cycle envelope curves, for a wider range of beam design parameters (i.e., beams that may not conform to the compactness or bracing requirements for Special Moment Frames). Where applicable, the parameters from NIST (2017b) are recommended as they are more up to date with available test data.*

4.6.4.2 Steel columns in bending

Determine moment-rotation response using parameters in NIST (2017b) or ASCE 41.

Commentary: *NIST (2017b) provides parameters for establishing both the monotonic backbone and first-cycle envelope curves for steel columns that generally conform to the design requirements for Special Moment Frames in AISC 341. ASCE 41 provides parameters, based on the first-cycle envelope curves, for a wider range of beam design*

parameters. Where applicable, the parameters from NIST (2017b) are recommended as they are more up to date with available test data.

4.6.4.3 Steel beam-column joint panel zones

Include the effect of panel zone distortion on overall frame stiffness and on the plastic rotation capacity of fully restrained moment connections. Model the panel zone using guidelines and parameters in NIST (2017b).

Commentary: *Experimental evidence indicates that deterioration in the shear force–shear distortion response of a joint panel zone is small unless shear buckling occurs. The latter mode is unlikely to occur when connections conform to AISC 341 detailing criteria. Thus, it should be acceptable to neglect deterioration in the modeling of joint panel zones unless there is clear indication that deterioration will occur within the range of deformations expected at maximum considered response levels. Elastic and inelastic straining of panel zones should be modeled unless simplified models (e.g., using member centerline dimensions) are demonstrated to adequately model the response.*

4.6.4.4 Steel column bases

Include the effect of column base distortion on overall frame stiffness and on the column moments.

Commentary: *In tall buildings, the steel columns typically extend into the basement, creating a column backstay, wherein the column base fixity does not have a significant influence on the overall frame response or column behavior. However, where column base fixity may have a significant effect, the flexibility of the column base plate and anchorage should be considered in the analysis model. Kanvinde et al. (2012) provides guidelines on modeling column baseplate response.*

4.6.4.5 Steel EBF link beams

Develop force-deformation response of EBF links based on results of physical tests, particularly if non-standard boundary conditions are employed. Where applicable, the nonlinear modeling parameters in ASCE 41 may be used.

4.6.4.6 Steel axially loaded braces

Construct the model to represent post-buckling deterioration, ductile tearing due to localized strain reversal during post-buckling cyclic loading and fracture at connections. Model buckling braces using the nonlinear modeling parameters in ASCE 41.

Commentary: *Once braces buckle, their strength degrades rapidly, which can lead to excessive story drifts due to localization of damage. Therefore, the use of buckling braces is discouraged for tall buildings. Braces in frame configurations and in outriggers depend strongly on the ability of the connections to transfer pre- and post-buckling forces from the brace to horizontal and vertical chord members. Additional strain may be placed on the connection by relative rotations of the chord members at the brace intersections. It is of paramount importance to consider all conceivable failure modes at the brace connection when assigning strength and deformation parameters to the bracing member. Post-buckling modeling and ductile tearing depends strongly on brace section and slenderness ratio. References on these deterioration and failure modes, along with modeling criteria, include*

Chapter 4 of NIST (2017d), Jin and El-Tawil (2003), Uriz (2005), Uriz et al. (2008), Fell et al. (2006), and Fell (2008).

4.6.4.7 Steel buckling-restrained braces

Model buckling-restrained braces based on cyclic test data, which account for cyclic hardening and the difference in yield strength in tension and compression. Account for the stiffness of the brace connections and the relative length of the yielding core region relative to the overall member length.

4.6.4.8 Steel plate shear walls

Construct the model to represent the effective story shear strength and stiffness, including the pinching effect caused by tension field reversal, deterioration due to connection failures, and possible deterioration due to combined bending and axial load effects in the vertical boundary elements. If cyclic strip models are used, employ a sufficient number of strips to adequately simulate the column bending moments due to force transfer between the shear wall panel and the vertical boundary elements.

Commentary: *At large story drifts, the combined bending and axial load capacity of the vertical boundary elements might deteriorate due to shear racking that causes large localized rotations in these boundary elements. P-Delta effects might become a critical issue if the shear wall deforms in a shear racking mode that concentrates inelastic deformations in the lower stories. Information on modeling of steel plate shear walls can be found in AISC 341 (2016) and in the many references listed in that publication.*

4.6.5 Reinforced Concrete Components

4.6.5.1 Reinforced concrete beams in bending

Determine moment-rotation response using parameters in NIST (2017c) or ASCE 41.

For T-beams, where: (1) the slab is integral with the beam, (2) the flange is in tension under moments at the face of the joint, and (3) the flange reinforcement is developed at the critical section for flexure; include the flange reinforcement within an effective flange width defined in ACI 318 as part of the flexural tension reinforcement when calculating M_{ne} . Include the effect of prestressing in all cases.

Commentary: *NIST (2017c) provides parameters for establishing both the monotonic backbone and first-cycle envelope curves for concrete beams that generally conform to the design requirements for Special Moment Frames in ACI-318. ASCE 41 provides parameters, based on the first-cycle envelope curves, for a wider range of beam design parameters (i.e., beams that may not conform to the design and detailing requirements for Special Moment Frames). Modeling guidelines in both documents have been derived from databases containing experimental results from column tests, where the model parameters have been extrapolated to cases with an axial load of zero to be applicable for beams. This process may not be fully justified because beams may have unequal top and bottom longitudinal reinforcement and no distributed side face reinforcement, and in most cases have contributions from a slab system. Guidance for modeling slab contributions can be found in Moehle and Hooper (2016) and Moehle (2014).*

In concrete structures with prestressed slabs, the beam strength can be calculated by assuming the average prestress on the combined slab-beam system acts on the T-beam

cross section. For beams at the edge of the building and spanning perpendicular to the edge, the positioning of the prestressing tendons may be such that the effective prestress does not act on the critical T-beam cross section, in which case the effect of prestressing need not be considered.

4.6.5.2 Reinforced concrete columns in bending

Determine the moment-rotation response using parameters in NIST (2017c) or ASCE 41.

Commentary: *NIST (2017c) provides parameters for establishing both the monotonic backbone and first-cycle envelope curves for concrete columns that generally conform to the design requirements for Special Moment Frames in ACI-318. ASCE 41 provides parameters, based on the first-cycle envelope curves, for a wider range of column design parameters (i.e., columns that may not conform to the design and detailing requirements for Special Moment Frames).*

4.6.5.3 Reinforced concrete beams and columns in shear

Model shear in concrete beams and columns as elastic, force-controlled actions.

4.6.5.4 Reinforced concrete slabs in slab–column frames

Model concrete slabs and slab–column connections using guidelines in Chapter 4 of ATC 72 (2010) and ASCE 41.

Commentary: *Slab–column framing can be represented using either an effective beam-width model or an equivalent-frame model. Where deformations exceed the yield point at a connection, it may be convenient to insert a nonlinear rotational spring between the components representing the slab and the column. In some cases, it may be convenient and acceptably accurate to lump several slab–column connections into a single beam–column assembly that represents the effective stiffness and strength of several isolated connections (Yang et al., 2010).*

4.6.5.5 Reinforced concrete beam–column joints

Model shear behavior in concrete beam-column joints as elastic, force-controlled actions using guidelines in NIST (2017c), Moehle (2014), or ASCE 41.

Commentary: *Where ACI-318 seismic design provisions for joint design are followed, joint shear deformations can typically be accounted for by using reduced rigid end offsets at the ends of the connected beams and columns. Provisions of ASCE 41 or Moehle (2014) are recommended to define the effective end offsets. Bond slip of longitudinal reinforcement in the joint region is best represented in the models of the beams and columns framing into the joint; these effects are included in the effective elastic stiffness parameters and the inelastic beam hinge models of Table 4-3.*

4.6.5.6 Reinforced concrete shear walls in bending and shear

Model combined axial and bending behavior of concrete walls using either fiber or moment-curvature models based on realistic cyclic material models. Model shear in concrete as a force-controlled elastic action.

Commentary: *Both fiber and moment-curvature models can provide good representations of wall bending behavior over the full height of the wall. Shear behavior is usually decoupled*

from bending behavior. Information on modeling of flexural and shear strength and stiffness properties of beam–column models and fiber models are presented in Chapter 4 of ATC 72 (2010). Most of the models presented in ATC 72 do not address deterioration due to longitudinal reinforcement buckling and fracture, which necessitates the specification of strain limits to account approximately for these critical deterioration modes. Analytical computation of strain can be very inaccurate, especially for elements where inelastic deformation is concentrated in localized regions. Such regions commonly occur where material behavior is strain-softening. Common examples where strain-softening occurs include (a) unconfined concrete strained past the peak of the stress–strain relation and (b) very lightly reinforced sections where the strength after cracking is less than the cracking strength. Where such behavior occurs, it may be necessary to regularize the strain gauge length so as to represent these local effects (Pugh et al., 2015). Where these effects are avoided, it is usually acceptable to use a strain gauge length of approximately one story height but not more than one-half of the wall length, l_w .

It is often assumed that regions of a wall outside the designated yielding region can be modeled with elastic models. However, seismic force demands at the MCE_R response level in tall and slender wall structures depend very much on inelastic redistribution and higher-mode effects, which might lead to large moment and shear force amplifications compared with values estimated from elastic behavior. Therefore, it is necessary to perform a comprehensive post-analysis demand/capacity review of the structure to verify that the demands in all protected regions outside the designated plastic-hinge zone are indeed small enough to justify the assumption of elastic behavior. The results might disclose the need for re-design. Alternatively, where flexural yielding is indicated in middle or upper story levels, it is often preferable to modify the analysis model by extending nonlinear elements over the full wall height. Minor flexural yielding often can be accommodated without significant changes to the structural design.

For structural concrete walls having height-to-length ratio $h_w/l_w \geq 2$, with mean of the maximum calculated concrete compressive strain $\varepsilon_c \leq 0.005$ and mean of the maximum calculated longitudinal reinforcement tensile strain $\varepsilon_s \leq 0.01$ at all points in a cross section, limit the expected shear strength of the wall to:

$$V_{ne} = 1.5A_{cv} \left(2\lambda\sqrt{f'_{ce}} + \rho_t f_{ye} \right) \leq 15A_{cv} \sqrt{f'_{ce}} \quad (4-2)$$

Commentary: Tests on slender walls failing in shear show that shear strength decreases with increasing inelastic flexure (Moehle, 2014; Tran et al., 2017). The shear strength determined from Equation (4-2) is applicable to walls with relatively low flexural ductility demands. For other walls, shear strength can be calculated in accordance with ACI 318, with appropriate substitution of expected material strengths.

For structural wall panel zones, limit V_{ne} to

$$V_{ne} = A_{cv} \left(3\lambda\sqrt{f'_{ce}} + \rho_t f_{ye} \right) \leq 25A_{cv} \sqrt{f'_{ce}} \quad (4-3)$$

where ρ_t the smaller of the steel ratios of the distributed horizontal or vertical reinforcement in the panel zone.

Commentary: Panel zones are regions of structural walls that act as connections between intersecting wall segments or between walls and other structural elements. Figure 4-9 illustrates four examples of panel zones. Such regions can be subjected to relatively high shear stresses resulting from force transfers under lateral loads. Villalobos et al. (2016) showed that shear strength of wall panels can be expressed by Equation (4-3).

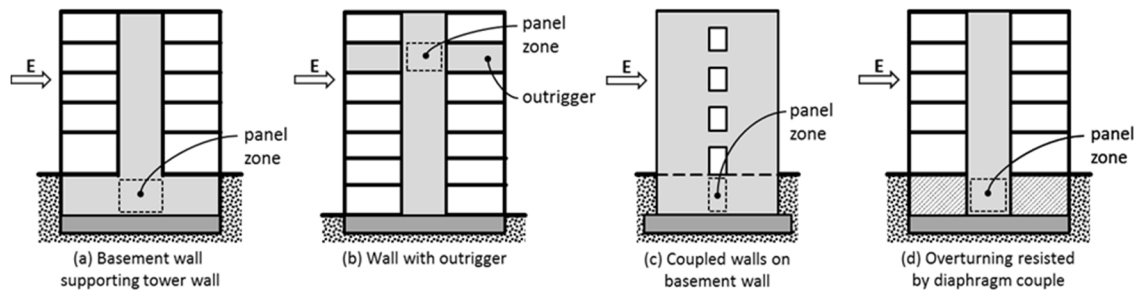

Figure 4-9 Examples of panel zones in structural walls.

4.6.5.7 Reinforced concrete coupling beams

Use the modeling recommendations of NIST (2017c) or ASCE 41 for conventionally reinforced coupling beams that are flexure-controlled. For diagonally reinforced coupling beams, calculate moment strength contribution from diagonally placed reinforcement based on the horizontal component of the force in the diagonal reinforcement. Include in the beam moment strength the contribution of the slab that is cast monolithically with the beam.

Commentary: Coupling beams that are part of the primary seismic-force-resisting system in general should be flexurally controlled, such that shear is treated as a force-controlled action or should be diagonally reinforced.

Provisions for diagonally reinforced coupling beams are included in ACI 318 that allow two detailing options: one with transverse reinforcement around the groups of diagonal bars and the other with transverse reinforcement around the entire beam. Test results indicate that the load-displacement responses for the two detailing options are nearly the same.

Consideration should be given to the phenomenon that walls will “grow” on the tension side due to shifting of the neutral axis, which in turn will increase the vertical deflection at the wall-coupling beam interface and therefore will increase the coupling beam rotation demand.

For concrete walls with steel coupling beams, Motter et al. (2017) provides data for calibration of the coupling beam model parameters.

4.6.5.8 Non-standard components

For components whose design and behavior characteristics are not documented in applicable building codes and standards, develop appropriate design criteria and component models from analytical and physical test investigations. In general, physical test verification will be necessary for proposed models for inelastic behavior including deterioration.

4.6.6 Response Modification Devices

Model properties of response modification devices (such as seismic isolation, damping, and energy-dissipation devices) based on data from physical tests representing the conditions anticipated in MCE_R shaking. If there is significant variability in properties of these devices, the structure response simulations should use alternative models incorporating upper- and lower-bound properties. If there is a functional limit beyond which the devices cease to operate (for example, a displacement limit), represent this functional limit in the analytical model. It should be demonstrated that either the consequences of attaining this limit can be tolerated by the structure or that this functional limit is not breached in any of the analyses.

5 Service-Level Evaluation

5.1 SCOPE

This chapter sets recommended criteria for demonstrating the structure will perform acceptably in response to Service-Level Earthquake (SLE) shaking. These objectives are achieved by performing dynamic analysis using a linear-elastic model, although an option for nonlinear dynamic analysis also is provided. Both global response of the building and demands for individual structural components are evaluated against acceptance criteria selected for compatibility with these performance goals. In large part, these criteria are consistent with ASCE 7 Chapter 12 (or Chapter 16 if nonlinear analysis is used), with supplemental criteria deemed appropriate to tall buildings.

Commentary: *Commentary to Section 2.2.3 describes the performance goals upon which these Guidelines are based. These performance expectations assume that Service-Level shaking affects the building before (rather than after) more severe shaking occurs. Strong earthquake shaking may cause damage to structural and nonstructural components, and might render the building more susceptible to damage under Service-Level shaking that occurs at a later date. Repairs may be necessary to return a building to a serviceable condition. If severe damage has occurred under strong earthquake shaking, it may not be possible to repair the building to a serviceable condition.*

5.2 GENERAL SYSTEM REQUIREMENTS

5.2.1 Structural System Design

Configure, proportion, and detail the structural system to resist all applicable loadings specified by the building code in accordance with Chapter 2.

Exception: In lieu of the minimum strength requirements for seismic resistance specified by the building code, comply with these Guidelines.

5.2.2 Evaluation Criteria

Perform linear dynamic analysis, using either response spectrum or response history methods, in accordance with ASCE 7 Chapter 12 to evaluate acceptability of Service-Level response.

Exception: The ground motion specifications of Chapter 3 and the acceptance criteria of Section 5.7 of these Guidelines take precedence over those of ASCE 7 Chapters 11 and 12.

When desired as an alternative to linear dynamic analysis, perform nonlinear dynamic analysis in accordance with ASCE 7 Chapter 16 to evaluate acceptability of Service-Level response.

Exception: The ground motion specifications of Chapter 3 and acceptance criteria of Section 5.8 of these Guidelines take precedence over those of ASCE 7 Chapter 11 and Chapter 16.

5.3 SEISMIC HAZARD REPRESENTATION

Define SLE shaking as required in Chapter 3, with a minimum return period of 43 years (50% probability of exceedance in 30 years). Represent SLE shaking in the form of a site-specific, uniform hazard acceleration response spectrum, with damping as indicated in Section 4.2.7. If nonlinear response history analysis is to be performed as part of the SLE evaluation, select ground motions and modify them to be compatible with the SLE spectrum in accordance with the recommendations of Chapter 3.

Commentary: *SLE shaking is typically set at a return period of 43 years. Consequently, it can be reasonably expected that a tall building will be subjected to earthquake shaking at or exceeding this shaking level once or more during its service lifetime. This expectation has been taken into consideration in establishing the SLE criteria.*

Considering that intended response of the building to SLE shaking is essentially elastic, the primary approach for checking serviceability will be to use modal response spectrum analysis or response history analysis of a linear model of the structural system. It is permitted, however, to use nonlinear response history analysis. For either linear or nonlinear response history analysis, it will be necessary to select and scale earthquake ground motions to appropriately match the target response spectrum.

Under the prescriptive building code provisions, minimum strength requirements for a building are established using a Design Earthquake (DE) with two-thirds of the MCE_R shaking intensity. These Guidelines do not use the same DE, but instead use a two-level design approach, checking serviceability for SLE effects and stability for MCE_R effects. Consequently, many engineers will use SLE shaking, together with wind demands, to set the strength of the structure in preliminary design, with later confirmation of adequacy as part of the MCE_R shaking evaluation. In regions of relatively high seismicity, including Los Angeles, San Francisco, and Seattle, SLE shaking will result in required building strength that is of the same order as the strength required using the prescriptive building code procedures. However, in some cities with lower seismicity, including Portland, Oregon; Sacramento, California; and Salt Lake City, Utah, design for SLE shaking will result in substantially less required strength than would be required for conformance with the prescriptive building code provisions. Engineers designing buildings in locations with this lower seismicity should be aware of this and should understand that SLE strength requirements may not result in a building of adequate strength for the MCE_R evaluation. Note that a number of jurisdictions also require a DE (code-level) evaluation in addition to the SLE and MCE_R evaluations. Appendix C provides guidance on implementation of a DE check within the context of the other recommendations presented in these Guidelines, should this be required or desired.

ASCE 7 requires that buildings assigned to Risk Categories III and IV have minimum design strength at least 125% or 150%, respectively, of the strength required for buildings in lower Risk Categories. For Risk Category III buildings, ASCE 7 intends only that greater protection of life safety be provided, through more robust collapse resistance, as opposed to enhanced serviceability. These Guidelines take this same approach. For Risk Category IV buildings, ASCE 7 intends that buildings be useable, possibly in an impaired mode, after design-level shaking. This performance could be achieved by performing a SLE evaluation for earthquake shaking having a return period longer than 43 years. Jurisdictions that desire to have a higher level of community resilience could use a similar approach for tall buildings.

Regardless of the return period used for the SLE evaluation, the free-field design spectrum obtained from seismic hazard analysis should not be reduced for embedment or kinematic effects unless specific soil–structure–interaction analyses are undertaken.

5.4 STRUCTURAL MODELING AND ANALYSIS

5.4.1 General

Construct a three-dimensional model of the structural system in accordance with Chapter 4 of these Guidelines and conduct linear dynamic analysis in accordance with Chapter 12 of ASCE 7, except as modified by this section. The SLE evaluation shall include either a response spectrum analysis or linear response history analysis. Linear response history analysis can be carried out by either (a) applying two components of ground motions in the X- and Y-directions simultaneously or (b) applying the X-component ground motions and the Y-component ground motions in separate analyses.

Response parameters, including forces and displacements, termed herein Linear Response Parameters, shall be used to evaluate acceptable performance.

Commentary: *The results of SLE linear response spectrum or linear response history analysis should not be modified by response modification coefficients, R , or overstrength factors, Ω_0 , nor should the results be scaled to minimum base-shear criteria. Rather, the displacement and strength demands computed from the linear response spectrum or linear response history analysis should be compared directly with the acceptance criteria of Sections 5.6 and 5.7.*

When demand-to-capacity ratios determined from such linear analysis exceed acceptable levels, either the structure is to be redesigned or, alternatively, nonlinear response history analysis may be used to investigate and possibly demonstrate acceptable performance. When nonlinear modeling is performed, construct a three-dimensional analysis model in accordance with Chapter 4 of these Guidelines and conduct nonlinear response history analysis in accordance with Chapter 16 of ASCE 7, using not less than seven horizontal ground motion pairs. Perform analyses and determine acceptable performance of each response parameter with ground motions selected and modified to be compatible with the Service-Level response spectrum. Element properties shall be based on expected strength values. Use the default values of Table 4-2 for the expected strength of common structural materials unless alternative properties can be justified. Where materials other than these are used, base expected strength values on statistical data from material tests and consider potential effects of strain hardening.

Commentary: *The displacement and strength demands computed from the nonlinear response history analysis should be compared directly with the acceptance criteria of Sections 5.6 and 5.8.*

For either linear or nonlinear analyses, explicitly incorporate in the model all components and elements of the gravity-force-resisting system that contribute significantly to lateral strength and stiffness, even if their failure would not result in endangerment of life safety.

5.4.2 Torsion

The mathematical model shall address torsional behavior of the building. Inherent eccentricities resulting from the distribution of mass and stiffness shall be included. Accidental eccentricities need not be considered for serviceability evaluation.

Commentary: ASCE 7 requires consideration of accidental eccentricities when determining the forces and displacements used for design. These accidental eccentricities are intended to ensure that the structure is torsionally stable and to account for the real torsional conditions that occur even in nominally symmetric buildings because of variation in material strength, tenant build-out, furniture, and storage loads. These Guidelines do not require consideration of accidental torsion for SLE shaking. Instead, susceptibility to torsional response, including accidental torsion, is considered for the MCE_R evaluation.

5.4.3 Foundation–Soil Interface

Soil–foundation–structure interaction analysis is not encouraged for SLE evaluation.

Commentary: Soil–foundation–structure interaction typically has little effect on the response of tall buildings at SLE demand levels. Its effect is most significant with regard to the demands on basement walls and slabs, which have typically been demonstrated to be robust in moderate-level shaking. Detailed soil–structure–interaction analysis is therefore not necessary for SLE evaluations where simple yet generally conservative assumptions suffice.

5.4.4 Subterranean Levels

The analytical model of the structure:

1. May ignore the horizontal effect of soil surrounding the subterranean levels; and
2. May assume rigid soil beneath the foundations (that is, no vertical soil springs).

5.5 DESIGN PARAMETERS AND LOAD COMBINATIONS

Evaluate story drifts and member forces (axial, moment, shear, and torsion) for all members of the lateral-force-resisting system.

5.5.1 Load Combinations: Linear Modal Response Spectrum Analysis

Evaluate the structure for strength and drift for the following load combinations:

$$1.0D + 0.5L + 1.0E_x + 0.3E_y \quad (5-1)$$

$$1.0D + 0.5L + 0.3E_x + 1.0E_y \quad (5-2)$$

Take live load, L , as 80% of unreduced live loads that exceed 100 pounds per square foot (4.79 kN/m²) and 40% of other unreduced live loads.

Commentary: Building code response modification factors do not apply to serviceability evaluation (that is, R , Ω_0 , ρ , and C_d are all taken as 1.0). Vertical seismic ground motions are not included in the SLE load combinations because their effect is felt to be negligible at this hazard level, and effects of vertical motions, where required, will be evaluated more critically under MCE_R evaluation of Chapter 6.

5.5.2 Load Combinations: Linear Response History Analysis

When linear response history analysis is carried out by applying two components of ground motions in the X- and Y-directions simultaneously, evaluate the structure for strength and drift for the following load combination:

$$1.0D + 0.5L + 1.0E \quad (5-3)$$

where L shall be taken as described in Section 5.5.1.

When linear response history analysis is carried out by applying the X-component ground motions and the Y-component ground motions in separate analyses, evaluate the structure for strength and drift for load combinations (5-1) and (5-2).

5.5.3 Load Combinations: Nonlinear Response History Analysis

When nonlinear response history analysis is used for SLE evaluation, evaluate the structure for load combination (5-3).

5.6 GLOBAL ACCEPTANCE CRITERIA

5.6.1 Story Drift Limit

Calculated story drift shall not exceed 0.5% of story height in any story, computed at extreme points for each floor plan in each of two orthogonal plan directions.

Commentary: The story drift limit of 0.5% for SLE shaking is intended to provide some protection of nonstructural components and also to ensure that permanent lateral displacement of the structure will be negligible. Extreme points on the floor plans are evaluated to help ensure that torsional response is properly controlled. It is important to understand that at a story drift of 0.5%, nonstructural damage, particularly for elements such as interior partitions, may not be negligible and considerable cosmetic repair may be required. Evaluation of damage to nonstructural elements can be performed using tools such as FEMA P58.

5.7 COMPONENT ACCEPTANCE CRITERIA—LINEAR ANALYSIS

5.7.1 Deformation-Controlled Actions

When response spectrum or linear response history analysis is used for the SLE evaluation, calculated demand-to-capacity ratios for deformation-controlled actions shall not exceed 1.5, where demand is calculated from load combinations in accordance with Section 5.5, and capacity is calculated as follows:

1. For reinforced concrete elements, the capacity is defined as the nominal strength in accordance with ACI 318 without applying the corresponding strength reduction factor ϕ .
2. For structural steel and composite steel and concrete elements, the capacity is defined as the nominal LRFD strength in accordance with AISC 341 and AISC 360, which is taken as the nominal strength without applying the corresponding resistance factor ϕ .

Commentary: For deformation-controlled actions, nominal strengths are calculated using conventional procedures of ACI 318, AISC 341, and AISC 360, using nominal (specified) strength values without the strength reduction (resistance) factors of those standards. It is anticipated that expected strengths will be higher than the nominal strengths. Consequently, the demand-to-capacity ratio of 1.5 based on design strengths can be expected to result in only minor inelastic response.

5.7.2 Force-Controlled Actions

Calculated demand-to-capacity ratios for force-controlled actions shall not exceed 1.0, where demand is calculated from load combinations in accordance with Section 5.5, and capacity is calculated as follows:

1. For reinforced concrete elements and their connections, the capacity is defined as the design strength, taken as the nominal strength multiplied by the corresponding strength reduction factor ϕ in accordance with ACI 318.
2. For structural steel elements, for composite steel and concrete elements, and for their connections, the capacity is defined as the LRFD strength, which is taken as the nominal strength multiplied by the corresponding resistance factor ϕ in accordance with AISC 341 and AISC 360.

Commentary: For force-controlled actions, strength reduction (resistance) factors ϕ of ACI 318, AISC 341, and AISC 360 and a demand-to-capacity ratio of 1.0 have been defined to promote a strength hierarchy in which yielding occurs in deformation-controlled actions before force-controlled actions. However, these factors alone may be insufficient to ensure that an appropriate yielding mechanism occurs. It is not uncommon, therefore, to design a structure to satisfy all the SLE evaluation requirements only to find during the MCE_R evaluation that the force-controlled actions are overloaded, requiring time-consuming and expensive redesign. The structural engineer is encouraged to be conservative in the proportioning of force-controlled actions and to employ capacity design concepts in conceptual design to promote desired yielding mechanisms. Ultimately, only the results of

the MCE_R evaluation (Chapter 6) will be indicative of the likely yielding mechanisms and their associated internal deformations and forces.

These Guidelines do not provide more restrictive requirements for Risk Category III buildings in the SLE evaluation since the building code focuses primarily on limiting the probability of collapse for that Risk Category. If a higher level of certainty of meeting the service-level performance goals is desired for Risk Category III and IV buildings, a lower demand-to-capacity ratio for the deformation-controlled actions (for example, $1.5/1.25 = 1.2$ for Risk Category III buildings) can be applied.

5.8 COMPONENT ACCEPTANCE CRITERIA–NONLINEAR ANALYSIS

5.8.1 Deformation-Controlled Actions

Calculated deformations shall be less than those that result in damage that (a) exceeds minor cracking of concrete or yielding of steel in a limited number of structural elements, (b) impairs the ability of the structure to survive MCE_R shaking, (c) results in unacceptable permanent deformation, or (d) requires repairs beyond that which is necessary to restore appearance or protection from water intrusion, fire, or corrosion. Repair, if required, should not require removal and replacement of structural concrete other than cover, nor should it require replacement of reinforcing steel or structural steel. Acceptance criteria shall be demonstrated by appropriate laboratory testing. In lieu of the use of laboratory test data, it shall be permissible to use the acceptance criteria for Immediate Occupancy performance as contained in ASCE 41.

5.8.2 Force-Controlled Actions

Calculated inelastic deformations shall not occur in force-controlled actions.

Calculated force-controlled actions shall not exceed expected strengths. Expected strengths shall be based on laboratory tests. Alternatively, as required in Chapter 4, expected strength shall be taken equal to the design strength of ACI 318, AISC 341, or AISC 360, using expected materials strengths instead of specified material strengths, and using corresponding resistance factor ϕ in accordance with ACI 318, AISC 341, and AISC 360. Refer to Section 4.6 for expected strengths.

6 MCE_R Evaluation

6.1 SCOPE

This chapter sets recommended criteria for demonstrating the building will perform acceptably in response to MCE_R shaking. The performance goals for MCE_R shaking are (1) an acceptably low probability of incurring building collapse; (2) an acceptably low probability that the building would experience such large residual drift that large portions of the City surrounding the building would be judged at risk of endangerment in aftershocks; and (3) an acceptably low probability that cladding will fall from the building and present a hazard to pedestrians. These objectives are achieved by performing nonlinear response history analysis using a suitable suite—or suites—of ground motions representing MCE_R shaking. Both global response of the building and demands for individual structural elements are evaluated against acceptance criteria selected for compatibility with these performance goals. In large part, these criteria are consistent with ASCE 7 Chapter 16, with supplemental criteria deemed appropriate to tall buildings but less stringent requirements for accidental torsion.

Commentary: *The ASCE 7 seismic design procedures are intended to result in buildings that have an acceptably low conditional probability of collapse when subjected to MCE_R shaking as given in ASCE 7 Table 1.3.2, and repeated in Commentary to Section 2.2.3 of these Guidelines.*

The conditional probability of collapse for a building, at a particular ground motion intensity, is a function not only of the structural strength, deformation capacity, and nonlinear response characteristics, but also of a number of uncertainties including our ability to predict the ground motion characteristics and to model and simulate the building response given the ground motion. For certain classes of structural systems, the technical capability exists to calculate the probability of collapse as a function of ground motion intensity (e.g., FEMA P695). However, such calculations are complex and are based on the assumption that the force-deformation characteristics of all important structural components can be modeled for the full range of deformations leading to collapse. At the time of this writing, insufficient knowledge exists to model such behavior with confidence for all types of structural components that might be used in tall buildings. Furthermore, the software tools available to engineers do not permit such evaluations within the resources and time constraints available on most design projects. Until such knowledge and software tools are available, the evaluation procedure recommended in this chapter is the preferred method for providing adequate safety against collapse.

Rather than rigorously computing a collapse probability for the building, these Guidelines require that, for a moderately large suite of ground motions, the calculated response satisfy the following:

- (1) *Unacceptable response, such as instability, response beyond the valid range of modeling, or response suggesting failure of critical elements does not occur or occurs in an acceptably small fraction of the ground motions;*
- (2) *Strength demands on force-controlled actions or elements are sufficiently smaller than the expected strength capacities such that the probability of failure is acceptably small;*

- (3) *Deformation demands on deformation-controlled (ductile) actions or elements are within deformation limits that have been verified by testing as being sustainable without critical strength loss; and*
- (4) *Residual drifts are within acceptable levels.*

In these procedures, uncertainty in modeling, response simulation, and capacity determination are accounted for in an approximate manner as specifically described below and in Commentary to ASCE 7 Chapter 16. It should be noted that these Guidelines adopt more stringent drift limits than permitted in ASCE 7. This is likely to result in improved performance relative to buildings that are designed closer to the larger drift limits permitted by ASCE 7.

6.2 GENERAL REQUIREMENTS

6.2.1 Structural System Design

Configure, proportion, and detail the structural system to resist all applicable loadings specified by the building code in accordance with Chapter 2.

Exception: In lieu of the minimum strength requirements for seismic resistance specified by the building code, comply with these Guidelines.

6.2.2 Torsion Sensitivity Check

Conduct analysis of a linear model of the building to check susceptibility of the building to accidental torsion effects. For this purpose, the following steps are recommended:

- Establish a linear structural analysis model in accordance with the recommendations of Section 4.3 of these Guidelines.
- Conduct analysis in accordance with the Equivalent Lateral Force Procedure or the Modal Response Spectrum Procedure of ASCE 7 Chapter 12 using seismic shaking demands as represented by the SLE evaluation response spectrum.
- Calculate floor level displacements considering inherent torsional moment, M_t , and, separately, including inherent torsional moment plus accidental torsional moment, M_{ta} , caused by assumed displacement of the center of mass each way from its actual location by a distance equal to 5% of the dimension of the structure perpendicular to the direction of the applied forces. Where earthquake forces are applied concurrently in two orthogonal directions, the required 5% displacement of the center-of-mass need not be applied in both of the orthogonal directions at the same time, but shall be applied in the direction that produces the greater effect.
- Calculate a twisting index $A_x^* = (\delta_{\max,ta} / \delta_{\max,t})$ where $\delta_{\max,t}$ = the maximum displacement at Level x computed considering inherent torsion, and $\delta_{\max,ta}$ = the maximum displacement at Level x computed considering inherent plus accidental torsion.

- Where the calculated value of A_x^* exceeds 1.2 at any level, consider effects of accidental torsion in nonlinear dynamic analyses carried out as part of the MCE_R evaluation.

Commentary: *In this Guideline, the requirement for when accidental torsion needs to be considered in the MCE_R evaluation differs from the requirement of ASCE 7. In ASCE 7 Chapter 16, accidental torsion is required to be considered wherever certain types of horizontal torsional irregularity exist. In contrast, according to these Guidelines, accidental torsion need only be considered where linear structural analysis indicates that the response is significantly affected by accidental torsion. The triggering value of $A_x^* > 1.2$ is based on the judgment of the authors of this Guideline checked against a small population of actual buildings.*

6.2.3 Evaluation Criteria

Perform nonlinear dynamic analysis in accordance with ASCE 7 Chapter 16 to evaluate acceptability of MCE_R response.

Exceptions:

1. The acceptance criteria of Sections 6.7 and 6.8 of these Guidelines take precedence over those of ASCE 7, Chapter 16.
2. Evaluation in accordance with ASCE 7 Chapter 12, per ASCE 7 Section 16.1.2, is not required.
3. Accidental torsion need only be included in the analysis when the value of A_x^* calculated in accordance with Section 6.2.2, exceeds 1.2 at any level.

Commentary: *ASCE 7 Chapter 16 requires that, in addition to nonlinear analysis at the MCE_R level, one of the permissible elastic analysis procedures of Chapter 12 shall also be performed and that, with few exceptions, the building shall be demonstrated to comply with the applicable criteria of Chapter 12. Among other things, Chapter 12 requires that the designated lateral-force-resisting system meet minimum strength criteria, which serves two purposes: (1) It is an indirect means of providing adequate collapse resistance in MCE_R shaking; and (2) it provides damage protection for more frequent ground shaking. The authors of these Guidelines believe that the nonlinear analysis required herein is a more direct evaluation of collapse resistance than the linear procedures of ASCE 7 Chapter 12 and also believe that the SLE evaluation of Chapter 5 provides more consistent protection of structures for more frequent ground shaking.*

Regardless, some jurisdictions have historically required analysis and design in accordance with ASCE 7 Chapter 12, in addition to the SLE and MCE_R evaluations of these Guidelines. In such jurisdictions, the SLE evaluation should still be performed to provide the intended uniform level of protection. In addition, it may be appropriate to take exceptions to the ASCE 7 Chapter 12 procedures in addition to those explicitly permitted by ASCE 7. Appendix C provides further guidance on these issues.

Nonlinear static analysis may be used to supplement nonlinear dynamic analysis as an aid to understanding yield hierarchy, overstrength, and effective R values when this is deemed desirable.

Commentary: *Nonlinear static analysis (pushover analysis) may be useful as a design aid, but it should not be relied upon to quantify response characteristics for tall buildings. This is because nonlinear static analysis is unable to reproduce many phenomena that are a consequence of inelastic dynamic response, such as shear force amplification in shear walls.*

6.3 SEISMIC HAZARD REPRESENTATION

Develop one or more target spectra to represent MCE_R shaking, and select and modify a suite of not less than 11 horizontal ground motion pairs for each spectrum in accordance with Chapter 3.

Exception: When Chapter 4 requires explicit consideration of vertical response analysis, select and modify a suite of not less than 11 ground motions, each having two orthogonal horizontal components and one vertical component.

6.4 STRUCTURAL MODELING AND ANALYSIS

Construct a three-dimensional model of the structural system in accordance with Chapter 4 of these Guidelines and conduct nonlinear response history analysis in accordance with Chapter 16 of ASCE 7.

Explicitly incorporate in the analysis model all components and elements of the gravity-force-resisting system that contribute significantly to lateral strength and stiffness, even if their failure would not result in endangerment of life safety. Also include representation of all ordinary and critical elements that might experience earthquake-induced failure at MCE_R response levels.

Exception: Critical and ordinary elements of the gravity-force-resisting system that do not significantly affect lateral response but that might be susceptible to failure at MCE_R response levels can be omitted from the model when it is demonstrated that demands and associated capacities can be separately checked for these elements.

Commentary: *In design of buildings according to the prescriptive provisions of the building code, where an intent is to ensure that the designated seismic-force-resisting system is fully capable of resisting the design seismic loads, the general modeling approach is to include only the seismic-force-resisting system in the structural analysis model. In these Guidelines, the intent is to obtain a best estimate of the behavior of the structural system under MCE_R shaking. Therefore, all components of the structural system that significantly affect dynamic response should be included in the analysis model.*

The first edition of these Guidelines required deformation compatibility evaluations for elements of the gravity-force-resisting system that did not affect building lateral stiffness and were not explicitly modeled. However, it was not clear if these compatibility evaluations should be conducted for mean estimates of demand or a higher fractile, nor was it clear whether expected or lower-bound values of capacities for these elements should be used. To provide reliability consistent with the intent of ASCE 7, this edition of the Guidelines requires that actions in such elements be treated as either deformation or force controlled, and that they be evaluated using the same acceptance criteria as elements of the lateral-force-resisting system. This will typically require inclusion of these components in the analytical model used to evaluate lateral response. However, it is acceptable to calculate

demands on these components using secondary models and imposed deformations similar to those obtained from the lateral response analysis when it can be demonstrated that this adequately estimates demands on these elements.

6.5 LOAD COMBINATIONS

Include representation of dead loads and expected live loads in the nonlinear analysis model. It is acceptable to represent these loads by the load combination $1.0D + 0.5L$, where L is 80% of unreduced live loads that exceed 100 pounds per square foot (4.79 kN/m^2) and 40% of other unreduced live loads.

Compute demands considering simultaneous application of ground motions in each of two orthogonal horizontal directions. When explicit evaluation of vertical earthquake effects is required, apply the three components of ground motion simultaneously.

When multiple target spectra and suites of ground motions are used, evaluate the acceptability of MCE_R response independently for each spectrum and suite of motions.

Commentary: *Nonlinear analysis is load-path dependent, and the results depend on combined gravity and lateral load effects. To achieve a best estimate of response, the gravity load applied in the analysis should be equal to the expected gravity load, as defined here. Section 6.8 requires checking force-controlled component actions for multiple load combinations. It is not, however, the intent to run nonlinear analyses under multiple load combinations but, instead, to run nonlinear analysis under the single load combination $1.0D + 0.5L$.*

In addition to the gravity load combination specified here, ASCE 7 Chapter 16 also requires consideration of a second load combination $1.0D + 0.0L$. That load combination need not be considered where the sum, over the entire structure, of the expected live load ($0.5L$) as defined above does not exceed 25% of the total dead load, and the unreduced live load intensity over at least 75% of the structure is less than 100 psf (4.79 kN/m^2). This latter load combination is not required in these Guidelines because it will seldom control the design of a tall building.

6.6 QUANTIFICATION OF GLOBAL AND LOCAL DEMANDS

Evaluate global and component acceptability using mean values of peak transient story drifts, residual story drifts, and peak force-controlled component actions, Q_T , in accordance with Sections 6.7 and 6.8.3.

Exception: When a ground motion produces an unacceptable structural response, as permitted in Section 6.7.1, rather than using the mean of the results for the complete suite or set of analyses, evaluate story drift or force-controlled actions using 120% of the median value from the complete suite or set of analyses including the unacceptable case, but not less than the mean of the values for the ground motions producing acceptable response.

6.7 GLOBAL ACCEPTANCE EVALUATION

Evaluate the building:

1. For unacceptable response in accordance with Section 6.7.1;
2. For peak transient story drift in accordance with Section 6.7.2; and
3. For residual story drift in accordance with Section 6.7.3.

Transient and residual story drifts are reported as the absolute values of story drift, and are calculated at extreme points for each floor plan in each of two orthogonal plan directions.

6.7.1 Unacceptable Response

Unacceptable response to ground motion shall consist of any of the following:

1. Analytical solution fails to converge;
2. Demands on deformation-controlled elements exceed the valid range of modeling;
3. Demands on critical or ordinary force-controlled elements exceed the element capacity;
4. Deformation demands on elements not explicitly modeled exceed the deformation limits at which the members are no longer able to carry their gravity loads;
5. Peak transient story drift ratio in any story exceeds 0.045; and
6. Residual story drift ratio in any story exceeds 0.015.

For Risk Category II buildings, where spectral matching of ground motion is not used, it shall be permitted to have one unacceptable response.

For Risk Category III buildings, where spectral matching of ground motion is not used, it shall be permitted to have one unacceptable response if a suite of not less than 20 ground motions is used in the analysis for a particular target spectrum.

For Risk Category IV buildings, unacceptable response shall not be permitted.

Commentary: *Items 1 through 4 are from ASCE 7-16 Chapter 16. Items 5 and 6 are in addition to requirements of ASCE 7-16. The maximum transient drift of 0.045 has been selected judgmentally. Nonlinear response history analysis beyond this drift limit is considered unreliable using currently available analysis tools.*

The allowance for Risk Category III buildings is an exception to ASCE 7-16, based on the following consideration: If the true conditional probability of collapse at MCE_R for a design is 5% as targeted by ASCE 7 for Risk Category III buildings, then there is still approximately a 10% chance that one motion in a suite of eleven ground motions will produce unacceptable response. However, if the suite is expanded to 20 motions, without additional unacceptable response, the likelihood that the true probability of collapse exceeds the ASCE 7 target value is similar to that obtained with one unacceptable response out of eleven motions for Risk Category II buildings. The intent is not that the suite of motions automatically expands to 20 for Risk Category III buildings. Rather, the intent is to permit the use of a larger suite of motions in the event that one unacceptable response is obtained in the suite of eleven. In

such case, it is permissible to expand the suite to demonstrate acceptable behavior, defined as not more than one unacceptable response in 20 ground motions.

In cases where scenario spectra are used and an unacceptable response is calculated for one of the ground motions in a suite selected to represent a particular scenario, it is acceptable to use a larger suite of motions to demonstrate acceptability only for those scenarios producing unacceptable response.

6.7.2 Peak Transient Story Drift

In each story, the mean of the absolute values of the peak transient story drift ratios from each suite or set of analyses shall not exceed 0.03.

Commentary: *ASCE 7 Chapter 16 permits peak transient story drift ratios as large as twice the values permitted in ASCE 7 Table 12.12-1. Except for masonry structures, this results in story drift ratio limits of 0.04 for Risk Category II buildings and 0.03 for Risk Category III buildings. These Guidelines recommend the limit of 0.03 for buildings in both risk categories because the use of a story drift limit of 0.03 has resulted in efficient designs that have been judged effective by review panels in recent tall building projects. There is general consensus that, up to this story drift, (1) buildings with proper yielding mechanisms and good detailing will perform well (without critical loss of strength), and (2) nonstructural components designed to accommodate the specified drift ratio will not pose a major life safety hazard.*

6.7.3 Residual Story Drift

In each story, the mean of the absolute values of residual drift ratios from the suite of analyses shall not exceed 0.01.

Commentary: *The residual story drift ratio of 0.01 is intended to protect against excessive post-earthquake deformations that likely will cause condemnation or excessive downtime to perform repairs of a building. Tall buildings with large residual drifts may pose concern of substantial hazards to surrounding construction in the event of strong aftershocks. Repair or demolition of tall buildings with large residual drifts also may pose community risks. This criterion is added to provide enhanced performance for tall buildings.*

6.8 COMPONENT ACCEPTANCE CRITERIA

6.8.1 General

Evaluate all element actions, including framing intended primarily as gravity framing, in accordance with this Section.

Commentary: *All elements of the primary lateral-force-resisting system and the gravity-force-resisting system are to be checked for actions resulting from combined gravity loads and MCE_R evaluation earthquake loads. Gravity-load-resisting elements can be modeled directly in the structural analysis model or, where gravity-load-resisting elements do not contribute significantly to lateral resistance, they can be checked independently based on the results of the MCE_R analyses. For reinforced concrete construction, checks are typically required for reinforced concrete slab-column and slab-wall framing and for gravity columns. Slab-column framing drift ratio can be treated as a deformation-controlled action, and the*

requirement for shear reinforcement can be determined in accordance with ACI 318 Chapter 18, with the MCE_R story drift ratio substituted for the design story drift ratio. Gravity column axial force, moment, and shear can be treated as force-controlled actions, with demands compared with design strengths in accordance with Equations (6-1) through (6-4). Alternatively, flexural rotation in a gravity column can be treated as a deformation-controlled action that is checked in accordance with Section 6.8.2. When treated as a deformation-controlled action, it is necessary to demonstrate that the column can reliably support gravity load combinations while undergoing the MCE_R drifts.

6.8.2 Deformation-Controlled Actions

If the ultimate deformation capacity (δ_u) associated with any mode of deformation in a component is exceeded in any of the response history analyses, it is permitted either to:

1. Assume the strength associated with this mode of deformation is negligible for the remainder of that analysis and evaluate the stability of the structure and the effects on related strength quantities, or,
2. Consider the analysis to have unacceptable response.

For this purpose, δ_u shall be taken as the valid range of modeling as demonstrated by comparison of the hysteretic model with suitable laboratory test data or as described in Chapter 4.

Commentary: *To implement this criterion it is necessary to define the ultimate deformation capacity for each deformation-controlled action. Ultimate deformation capacity is commonly taken as the mean value obtained from relevant tests at which substantial loss of capacity occurs or, if tests do not progress to this deformation, the limiting deformation for which testing was performed.*

Options 1 and 2 above can be accomplished directly by using modeling Options 1 to 3 in Section 4.4.3. Alternatively, Option 2 above can be accomplished through post-processing of analysis results, that is, checking for each ground motion the maximum values of individual deformation demands versus capacities.

Structural walls are sometimes modeled using fiber models. The fiber models should incorporate inelastic material models for both concrete and steel reinforcement, as follows:

- *Concrete models should include strength degradation based on the level of confinement provided. For example, a model for unconfined concrete might include a peak stress at compressive strain 0.002 with a descending backbone to 50% of the peak stress value at compressive strain 0.003 (δ_u). A model for concrete confined in accordance with ACI 318 special boundary elements might include a peak stress at compressive strain of 0.008 with a descending backbone to 80% of the peak stress value at compressive strain of 0.015 (δ_u). Beyond the 80% peak stress value, the models should include negligible strength given the uncertainty in behavior and limitations of hoop fracture and longitudinal buckling, unless substantiated by tests.*
- *Longitudinal reinforcement models should include strain hardening and negligible strength beyond tensile rupture, which is commonly set at a tensile strain of 0.05 in consideration of effects of low-cycle fatigue. The detailing requirements of Section 6.9.2 indirectly limit the calculated reinforcement tensile strains as a function of boundary element detailing.*

Provided that all of the response history analyses stay within the range of modeling and acceptable behavior is maintained, the analyses are considered valid and the response is considered acceptable.

Note that this evaluation approach represents a departure from the approach taken in ASCE 7. ASCE 7 evaluates the mean deformation demands, δ_u , against a factored deformation capacity at which gravity-load-carrying capability is lost. Recognizing that scant data are available to indicate the deformation at which gravity-load-carrying capacity is lost for various types of components, ASCE 7 permits the use of ASCE 41 acceptance criteria for Collapse Prevention performance. This corresponds to evaluating mean capacities against mean demands. Such an evaluation would permit a probability on the order of 40% that demands will exceed the ASCE 41 capacity, the effect of which is not known. According to these Guidelines, the effect of loss of a deformation-controlled action must be evaluated in each nonlinear dynamic analysis, or as a post-processing check for each analysis, and if it produces unacceptable response, it is evaluated as to acceptability under the requirements of Section 6.7.1 for global behaviors. The authors of this Guideline believe that this results in a more reasonable evaluation of the reliability of the building.

6.8.3 Force-Controlled Actions

Categorize all force-controlled actions as being either Critical, Ordinary, or Noncritical, in accordance with Section 2.2.5.

Commentary: *The Engineer of Record should identify force-controlled actions, and force-controlled actions should be categorized as being Critical, Ordinary, or Noncritical, subject to approval by the peer review. Appendix E provides recommended typical force-controlled actions and their categories.*

Where force-controlled actions are limited by a well-defined yield mechanism, evaluate adequacy of force-controlled actions in accordance with Equations (6-1) and (6-2).

$$(1.2 + 0.2S_{MS})D + 1.0L + E_M \leq \phi_s BR_n \quad (6-1)$$

$$(0.9 - 0.2S_{MS})D + E_M \leq \phi_s BR_n \quad (6-2)$$

where:

- D is the effect of service dead load
- L is the effect of service live load as defined in the building code. The load factor on L in Equations (6-1) and (6-3) is permitted to be reduced to 0.5 for all occupancies in which the unreduced live load is less than or equal to 100 psf (4.79 kN/m²), with the exception of garages or areas occupied as places of public assembly.
- B is a factor to account for conservatism in nominal resistance R_n , normally taken as having a value of 1.0. Alternatively, it can be taken as $B = 0.9R_{ne} / R_n$.
- S_{MS} is the MCE_R , 5%-damped, spectral response acceleration parameter at short periods adjusted for site class effects as defined in ASCE 7.
- E_M is the capacity-limited earthquake effect associated with development of the plastic capacity of yielding components, determined in accordance with the applicable material standard (ACI 318, AISC 341) or, alternatively, determined by

rational analysis considering expected material properties including strain-hardening where applicable.

- ϕ_s is the resistance factor defined in Table 6-1.
- R_n is the nominal strength of the force-controlled action, calculated using specified material strengths, in accordance with the applicable materials standard.

Commentary: Equations (6-1) and (6-2) are applicable only where the yielding mechanism fully limits the force-controlled action to which the equations are being applied. Example applications include: beam or column shear as limited by development of probable moment strengths at the ends of the beams or columns, respectively; axial force in columns in moment frames and braced frames where axial force is limited by the sum of probable strengths of beams or braces; forces on braces and their connections in eccentric braced frames; and forces on connections in concentric and buckling-restrained braced frames. These equations are not applicable to shear in wall piers because the mechanism is not uniquely defined; therefore, apparent higher-mode effects can result in substantially larger shears in these elements. When calculating the shear demands in columns of moment frames, the shear should be calculated considering that flexural yielding occurs at the ends of the column rather than in the adjacent beams or joint, because P-Delta effects and apparent higher-mode effects can increase column shears beyond those limited by yielding of the beams and joints.

The intent of this requirement is to produce a strength for force-controlled actions that is sufficient to resist the maximum actions that can be produced as the structure develops the intended plastic mechanism. This approach is commonly known as the capacity design approach. The result is intended to be similar to the result obtained by equivalent procedures defined in the applicable material standard.

Evaluate all other force-controlled actions for their adequacy to satisfy Equations (6-3) and (6-4):

$$(1.2 + 0.2S_{MS})D + 1.0L + 1.3I_e(Q_T - Q_{ns}) \leq \phi_s BR_n \quad (6-3)$$

$$(0.9 - 0.2S_{MS})D + 1.3I_e(Q_T - Q_{ns}) \leq \phi_s BR_n \quad (6-4)$$

where:

- I_e is the seismic importance factor appropriate to the Risk Category as defined in ASCE 7
- Q_T is the mean of the maximum values of the action calculated for each ground motion
- Q_{ns} is the non-seismic portion of Q_T
- R_n is the nominal strength for the action, determined in accordance with the applicable material standard
- R_{ne} is the expected value of component resistance

Exception: When explicit vertical response analysis is performed, and the effects of vertical response analysis are included in Q_T , the term $0.2S_{MS}D$ may be neglected in Equations (6-3) and (6-4).

Commentary: Equations (6-3) and (6-4) are generally applicable, but they typically are applied in cases where Equations (6-1) and (6-2) either do not apply or those equations produce design values exceeding those obtained by Equations (6-3) and (6-4).

Equations (6-3) and (6-4) were developed to produce target reliabilities consistent with those of ASCE 7 Chapter 16 but in a revised format. In ASCE 7 Chapter 16, load factor γ is applied to the seismic portion of the load to account for uncertainty and bias in both the computed seismic load effect and the resistance to that effect. In these Guidelines, the uncertainties in load and resistance are accounted for separately, as is done in traditional LRFD formulations. For critical force-controlled elements, the resistance factors specified by the materials standards are used as it is felt that the committees developing those standards are in the best position to determine the bias and uncertainties associated with their strength formulations. For ordinary and noncritical actions, the resistance factors are relaxed in order to accept a higher probability of failure. The load factor on the seismic portion of the load has been modified from that in ASCE 7 Chapter 16 because (a) uncertainty in resistance has been moved to the capacity side of the equation, as in traditional LRFD approaches, and (b) nominal strength, rather than expected strength, is used in the acceptance equations. The adoption of a more traditional LRFD formulation is intended to facilitate the correct interpretation and implementation of both the load and resistance sides of the design equation.

The load factor of 1.3 in Equations (6-3) and (6-4) has been set assuming a coefficient of variation in calculated record-to-record demands equal to 0.3. In addition, it is assumed that, owing to the small size of the suite of ground motions used to calculate the mean demand and uncertainty in modeling, there is an additional uncertainty of 0.2 associated with the calculated mean value of demand. To ensure that, on average, the target reliabilities specified in ASCE 7 are achieved, the derivations assume an average resistance factor of 0.85, a coefficient of variation in resistance of 0.15 and a ratio of mean expected resistance to nominal resistance specified by the materials standards (R_{ne}/R_n) of 1.1. These values are consistent with parameters suggested in NBS Special Publication 577 (1980).

Currently, neither ACI nor AISC specify resistance factors (strength reduction factors) specifically tuned to the seismic reliability targets specified in ASCE 7. Rather, these resistance factors are tuned to the target reliabilities for other loads (ASCE 7 Table 1.3-1). The bias factor B contained in Equations (6-3) and (6-4) is provided to adjust the resistance factors specified by the materials standards to the seismic target reliabilities, considering the inherent bias in the nominal strength equations contained in the materials standards. This bias is a function of both the ratio of expected material strength to minimum specified strength, as indicated in Table 4-2, and also inherent conservatism in the predictive equations specified by the materials standards. Typical structural steel nominal resistance values have an inherent bias of 1.1 owing to material strength variability and small conservatism, typically neglected, in the strength formulation. Therefore, we generally recommend using a value of $B = 1.0$ for structural steel elements. For reinforced concrete elements, both material variability and conservatism in the predictive strength formulation may be larger. The following example illustrates how the bias factor might be used where expected strength is substantially greater than nominal strength.

Consider the shear design of a structural wall in a Risk Category II building. For a typical wall, gravity loads do not produce wall shear, so $D = L = Q_{ns} = 0$. For Risk Category II, $I_e = 1.0$. A wall would be categorized as a critical element, therefore, according to Table 6-1, ϕ_s is obtained from ACI 318-14, which defines $\phi_s = 0.75$

because the wall is being designed for the shear corresponding to development of the wall flexural strength. Thus, Equation (6-3) reduces to:

$$1.3Q_T \leq 0.75BR_n$$

ACI 318-14 specifies $R_n = A_{cv} (2\sqrt{f'_c} + \rho_t f_{yt})$. However, as noted in Section 4.6.5.6 of these Guidelines, if the calculated wall compressive and tensile strains are low, then the expected strength is $R_{ne} = 1.5R_{n,exp}$, where $R_{n,exp}$ is the value of R_n calculated using expected material strengths, or approximately $1.15R_n$. Consequently:

$$B = 0.9R_{ne}/R_n = 0.9(R_{ne}/R_{n,exp})(R_{n,exp}/R_n) = 0.9(1.5)(1.15) = 1.55$$

Thus, Equation (6-3) reduces further to:

$$1.3Q_T \leq 0.75BR_n = 0.75(1.55)R_n = 1.16V_n$$

or, simply

$$1.12Q_T \leq V_n$$

The value of the bias factor, B , theoretically should be dependent on inherent variability in resistance, which is somewhat different for elements of different materials and types. However, study of the effect of variability of resistance on the value of B , within the expected range for typical structural elements, suggests that there is only weak dependence. Therefore, this has been neglected in the formulation of Equations (6-3) and (6-4), and component strength variability of 0.15 has been assumed to apply.

Table 6-1 Seismic resistance factors, ϕ_s .

Action Type	ϕ_s
Critical force-controlled element	ϕ as specified in the applicable material standard (ACI 318, AISC 360, AISC 341, AISC 358)
Ordinary force-controlled element	0.9
Noncritical force-controlled element	1.0

6.9 PROPORTIONING AND DETAILING

6.9.1 General Requirement

Provide structural proportions and details that enable structural components, and the structural system as a whole, to perform in a manner consistent with, or better than, the performance as simulated in the nonlinear structural analysis under MCE_R ground motions. Where proportions

or details are insufficient for the calculated results for any ground motion, the response shall be defined as an unacceptable response as identified in Section 6.7.1.

Commentary: *The general requirement is that the structural analysis model and the corresponding member and system proportions and detailing are to be consistent with one another. Where the structural analysis model assumes that no strength deterioration occurs, the structural proportions and details are to be sufficient, with reasonable confidence, to preclude strength degradation at anticipated response levels. Where strength degradation is simulated, the provided component proportions and details are to be sufficient, with reasonable confidence, to preclude loss of gravity load support at anticipated response levels. When the proportioning and detailing are insufficient to ensure performance at least equivalent to the calculated performance, as reflected by the analysis, the analysis is to be deemed unacceptable.*

6.9.2 Prescriptive Code Requirements for Proportioning and Detailing

Provide structural proportions and details at least equivalent to those required by the applicable material standard, unless justified by analysis and approved through peer review.

Commentary: *Most designs will use member proportions and details that satisfy the prescriptive provisions of the applicable material standard building code. For example, for special moment frames, the strong-column/weak-beam provisions will apply, with beams, columns, and joints detailed in accordance with ACI 318 or AISC 341 as applicable. Where less stringent proportioning, detailing, or both are proposed, these should be justified based on consideration of the performance objectives for the project, including consideration of uncertainties in the hazard, structural analysis, and performance of components and the overall structural system.*

6.9.3 Cladding Systems

Detail cladding systems, including the cladding itself and cladding connections to the structure, to avoid failure that would result in shedding of the cladding from the building when subjected to the mean of the absolute values of the peak transient story drifts in each story.

7 Presentation of Results

7.1 SCOPE

This chapter provides guidance on organizing and presenting calculations and documenting analyses to facilitate review by others.

7.2 GENERAL

Prepare, and discuss with the peer reviewer(s), a plan for documenting the design and performance evaluation of the building. Key elements of this documentation typically include the Basis of Design, the Geotechnical/Seismic Ground Motion Report, the Preliminary/Conceptual Design, design in accordance with Design Earthquake (DE) (if required), results of the Service Level Earthquake (SLE) Evaluation and Maximum Considered Earthquake (MCE_R) Evaluation, and Construction Documents.

***Commentary:** The plan for documenting the design and performance evaluation of the building should be clearly defined at the beginning of the peer review rather than as an unfolding process during review. This will help align the expectations of the various participants and promote a design and review process that is thorough, efficient, and timely.*

The detail of information developed by the design team for review will be directly related to the phase of the project, moving from the global to the specific as the design advances from concepts to final design. At all steps in the process, the design team should highlight assumptions that have substantial effect on the building response, as well as procedures, components, or systems that may be outside widely accepted standard practices.

Present documentation in a way that facilitates the efficient transfer of information to the peer reviewer(s).

***Commentary:** Interpretation of the results and validation of assumptions and design criteria are key elements in an effective presentation of results. More is not necessarily better. For example, presenting graphical results of key maximum response quantities with explanations of “what it means” is far more effective than submitting binders or computer-storage media full of raw analysis data. In addition, all spreadsheets key to the structural analysis or design should be accompanied by a fully worked-out example with narrative and visual aids to explain the spreadsheet operations.*

7.3 BASIS OF DESIGN

Prepare a Basis of Design document that describes the project, codes and references, all exceptions to building code requirements, performance objectives, gravity loading criteria, seismic hazards, wind demands, load combinations, materials, anticipated analysis methods, classification of deformation-controlled and force-controlled actions, acceptance criteria, test data to support new concepts, the geotechnical report, and the site-specific hazard report. Present the Basis of Design document to the peer reviewer(s) for review, comment resolution, and approval early in the design and review process.

Commentary: *The Basis of Design document is the first and, in many ways, the most critical document in the process. Once agreed to by all participants, the Basis of Design becomes the set of rules by which subsequent design and analyses are checked. Complete and clear documentation of the Basis of Design will help avoid misunderstandings later in the process and the potential for expensive revision and delayed progress. Generally, the more detail included in the document, especially as related to material response and acceptance criteria, the greater the chance for an efficient presentation and review process. Appendix C provides a recommended outline of the Basis of Design contents.*

7.4 GEOTECHNICAL/SEISMIC GROUND MOTION REPORT

Summarize the main recommendations from the Geotechnical/Seismic Ground Motion Report in the Basis of Design document, and include it in complete form as an Appendix to the Basis of Design document.

Commentary: *The geotechnical portion of the report, which provides design parameters for foundation elements, information on groundwater, retaining wall design pressures, etc., should provide information similar to that required for any major design project. Some of the subjects included in the report, such as stiffness and nonlinear displacement quantities of supporting soils, may be beyond the scope of a typical geotechnical report.*

The seismic ground motion report should document the seismic hazard analysis, resulting target response spectra, the selection of seed ground motions, methods for modifying seed ground motions, and the final ground motions recommended for response history analysis. The report should clearly identify the procedures used, including all pertinent assumptions. Refer to Chapter 3 for further details on the procedures to be followed and recommended contents of the seismic ground motion report.

7.5 PRELIMINARY/CONCEPTUAL DESIGN

Present a preliminary/conceptual design package that includes a design narrative of the structural system, similar to but potentially more fully developed than the narrative presented in the Basis of Design Document. Present drawings for both gravity- and lateral-force-resisting systems, including preliminary member sizes, wall thicknesses, etc. Provide proposed detailing approaches for ductile elements of the lateral-force-resisting system. Note major force transfers (for example, at podium and outrigger levels), and the design approach for these elements, including sample design calculations and preliminary detailing concepts. If damping or energy dissipation elements are to be incorporated, describe assumptions used in their initial design. Provide outline specifications for structural sections, highlighting material requirements that are unusual. Provide initial design calculations used to develop member sizes, including member stiffness assumptions, period calculations, etc. Provide sample capacity design calculations for major structural elements. If a full building model has been developed, present model input and basic results (story shears, story overturning moments, story drift plots, etc.).

7.6 DESIGN IN ACCORDANCE WITH THE BUILDING CODE DESIGN EARTHQUAKE REQUIREMENTS

Where required by the Authority Having Jurisdiction, provide design calculations to demonstrate that the building design satisfies proportioning, detailing, and strength and drift requirements of the building code considering the DE. Describe the analysis model used for this evaluation, including which elements are considered as part of the seismic-force-resisting system, the stiffness assumptions, mass and gravity loading, P-Delta effects, and boundary conditions. Present the load cases and combinations. Present calculations including design coefficients required to determine the design base shear. Show the seismic response spectrum. Present calculated periods, mode shapes, modal mass participation, torsional amplification, redundancy factors, and review for structural irregularities. Present DE analysis results, including plots of moments, shears, and axial forces as appropriate to the design, and including plots of story drift and displacement. Show illustrative sample design calculations with narrative for representative components, as well as summary results for all components, including both the seismic-force-resisting system and the gravity framing system. Demonstrate that shears and other actions in walls, diaphragms, columns, and other elements do not exceed maximum allowable values. For buildings where gravity loads induce lateral demands (e.g., buildings with sloping columns), discuss how the interactions are considered in the design.

7.7 SERVICE-LEVEL EVALUATION

Provide executive summary discussion. Re-state the response spectrum for this evaluation. Provide input analysis model with description of elements and modeling assumptions. Provide information needed to compare model with design drawings. When response history analysis is used, provide plots of story drifts, moments, shears, and axial forces on key elements that vary with height, showing the peak quantities for each ground motion, and discussing dispersion in major response quantities. Present base-shear results. Provide story-drift plots and compare with design-criteria limits. Provide maximum demand/capacity ratios for major structural elements. Discuss any elements that may exceed drift or capacity limits, and justify why exceeding the limits is acceptable if it is the intent to accept these. Note torsional response and, if significant, present plots to compare difference in responses at opposite corners of the building plan. Verify that results are consistent with criteria in the Basis of Design.

7.8 MAXIMUM CONSIDERED EARTHQUAKE EVALUATION

Provide executive summary discussion. Re-state response spectrum for this evaluation. Provide input analysis model with description of elements and modeling assumptions. Provide detailed description of nonlinear element modeling, with clear and complete discussion of assumptions. Provide information needed to compare model with design drawings. Present response history plots for acceleration, velocity, and displacement. Present base-shear and overturning-moment results. Provide plots over building height of story drifts (both transient and residual), moments, shears and axial forces on key elements, showing the peak quantities for each ground motion, the acceptable values, and the statistical quantity of demand against which it is compared. Note torsional response and, if significant, present plots to compare difference in responses at opposite corners of the building plan. Compare critical element deformation demands with capacity limits. Discuss any elements that may exceed drift or capacity limits. If special

elements (e.g., outriggers or damping or energy dissipation elements) are included in the design, provide a separate discussion of the response of these elements. Include evaluation of foundation structural elements, showing orbits of moment transfers between major core walls and foundation, and demonstrate that bearing stresses and deformations are within acceptable values. Describe and present results for all major force transfer elements, such as those occurring at podium levels and outriggers.

8 Project Review

8.1 THE REQUIREMENTS FOR INDEPENDENT PEER REVIEW

Engage independent peer review by one or more individuals acceptable to the Authority Having Jurisdiction and possessing experience and knowledge pertaining to the following items:

- (a) Earthquake hazard definition and selection and modification of ground motions for use in nonlinear response history analysis, including effects of soil–structure interaction if used in the development of ground motions.
- (b) Behavior of structural systems, including foundations and supporting soils, relevant to the building under consideration when subjected to earthquake loading.
- (c) Application of structural analysis software for use in nonlinear response history analysis and interpretation of analysis results.
- (d) Expertise in the use of physical tests to develop structural analysis models and associated acceptance criteria if such development will be required for the project.
- (e) The requirements of these Guidelines as they pertain to design of the type of structure under consideration.

Commentary: *Tall building design commonly entails advanced analysis of a structural system with design complexities that cannot be fully envisioned in the writing of a design guideline. Independent peer review brings subject-specific expertise and broadened perspective to identify material, configuration, and loading aspects of a building that warrant special attention. Design in accordance with these Guidelines also requires judgments that fall outside the prescriptive requirements of conventional designs, creating challenges for design review by the Authority Having Jurisdiction. For these reasons, most building departments require independent peer review when designs are submitted for permit under the alternative means and methods clause. This requirement is also included in ASCE 7. The writers of these Guidelines recommend the use of these Guidelines as part of a building approval process only if the review includes independent third-party review.*

In addition to technical expertise noted in this section, experience as a practicing engineer can help a reviewer or a review team understand the practical design conditions under which the Engineer of Record is working. For this reason, the peer review should include at least one individual with experience as a practicing engineer engaged in the design of tall buildings.

8.2 SELECTION AND REPORTING REQUIREMENTS

Following consultation with the design team and project owner, obtain approval of the peer reviewer(s) by the Authority Having Jurisdiction. The reviewer(s) shall provide a professional opinion to, and shall act under the instructions of, the Authority Having Jurisdiction.

Commentary: *The composition of the peer review panel typically should be jointly determined by the owner/design team and the building department. Owner involvement is relevant because of the financial investment they are making in the project and in its peer review. Design team involvement is important because of their intimate knowledge of the structural design as well as their knowledge of relevant expertise of individuals who might serve as peer reviewers. However, the final decision on selection of the peer review panel is the responsibility of the Authority Having Jurisdiction.*

There is no recommendation as to whether an individual person or firm, or a team of individuals and firms, provides the peer review. However, the peer reviewer or reviewers should jointly possess expertise in geotechnical engineering and seismic hazards, seismic performance of tall buildings, advanced application of structural analysis software and interpretation of results, and design and behavior of structures with elements of the type employed in the subject building. Reviewers should not bear a conflict of interest with respect to the project and should not be part of the project design team. In selecting peer reviewers, it is advisable to ascertain that the reviewer is able to commit the time required for the review such that it can proceed in a timely manner.

On many projects, peer review is provided by a team, often comprising three persons. One member typically is a practicing structural engineer who has the expertise to review the proposed structural system, with experience in structural engineering, performance-based earthquake engineering, nonlinear response history analysis, and tall building design. This engineer's supporting staff typically performs detailed reviews of structural analysis models implemented in computer software. Another member typically is an expert in seismic hazard analysis, the generation of site-specific ground motions and accelerograms for use in the nonlinear analyses, geotechnical engineering, or geological engineering. A third member typically possesses specialized expertise related to the proposed structural system, possibly a structural engineering researcher, with additional expertise in earthquake engineering, performance-based earthquake engineering, nonlinear response history analysis, and tall building design. There is, however, no requirement that a panel comprise three members. The number of members may be expanded or contracted as appropriate, provided the review team possesses expertise in all of the areas noted above.

When review is performed by a team, one team member should serve as the review team chair, who is responsible for (a) mediating disputes, if any, between the reviewers, and (b) responsible on behalf of the peer review team for maintaining the peer review record and for expressing the official positions and opinions of the review team. Some jurisdictions require that the chair of the review team be a structural engineer licensed to practice in the jurisdiction in which the structure is to be constructed, but that is not a general requirement of these Guidelines.

8.3 SCOPE OF WORK

Discuss the scope of the peer review among the owner, project design team, peer reviewer(s), and the Authority Having Jurisdiction, with final approval of the scope of work by the Authority Having Jurisdiction. Include in the scope of work the following items as a minimum:

- (a) Basis of Design document, including the seismic performance objectives, the overall seismic design methodology, and acceptance criteria;
- (b) Proposed structural system and materials of construction;

- (c) Earthquake hazard determination, and selection and modification of earthquake ground motions for application to the building model;
- (d) Modeling approaches for structural materials and components;
- (e) Structural analysis model, including soil–foundation–structure interaction as applicable, and including verification that the structural analysis model adequately represents the properties of the structural system within accepted norms for tall building designs;
- (f) Review of structural analysis results and determination of whether calculated response meets approved acceptance criteria;
- (g) Design and detailing of structural components;
- (h) Drawings, specifications, and quality control/quality assurance and inspection provisions in the design documents; and
- (i) Any other considerations that are identified as being important to meeting the established performance objectives.

Commentary: *It is important to have a clear definition of the peer review scope. The building official should define the minimum acceptable scope. In most cases, the review is limited to the seismic design, even though design for wind forces and deformations (specifically drift limits for serviceability and occupant comfort) may control the design of many tall buildings. The design of the building under gravity-only load combinations is generally excluded from the scope. However, consideration of gravity-load-resisting elements for forces and deformation compatibility issues as the structure responds to earthquake ground motions is generally included in the scope. Nonstructural elements that can create hazards to life safety are often included to ensure that proper anchorage and/or deformation accommodation has been provided. At the discretion of the Authority Having Jurisdiction, as well as other members of the project team, the scope of review may be expanded to include review of other building aspects, including wind design and critical non-structural elements.*

Based on the scope of review identified by the Authority Having Jurisdiction, the peer reviewer(s), either individually or as a team, should develop a written scope of work in their contract to provide engineering services.

8.4 PEER REVIEW PROCESS

Convene a meeting among the Engineer of Record, the Authority Having Jurisdiction, and the peer reviewer(s) to establish the scope of work, methods and lines of communication, the frequency and timing of review milestones, and the degree to which the Engineer of Record anticipates the design will be developed for each milestone.

Commentary: *The peer review process should initiate as early in the design process as reasonable. Early agreement and discussion of the fundamental design decisions, assumptions, and approaches will help avoid revisions later in the design process that will impact both the project cost and schedule. With projects of the size and complexity of typical tall buildings, there may be differences of opinion on a number of issues during the process that need to be negotiated between parties. The earlier in the process that these issues can be identified and resolved, the less effect they will ultimately have on the building cost and*

design and construction schedule. Early participation in the peer review should also help to establish a good working relationship with the design team.

The Authority Having Jurisdiction, the Engineer of Record, the peer reviewers, and possibly the owners should hold a kickoff meeting to establish expectations for the peer review. Normally, a kickoff meeting is held in person. The kickoff meeting should discuss scope of work, schedule, and any special communication or submittal requirements. It is a good idea at the kickoff meeting to establish a single point of contact for all parties involved, that is: (1) the Authority Having Jurisdiction, (2) the design team, and (3) the peer reviewer(s), with all subsequent communications to be directed through those individuals, with copies to other individuals if appropriate. Written communications should have an agreed-upon heading that identifies the project, such that it is easy to identify and file communications related to the project.

Although the kickoff meeting is usually held in person, subsequent meetings may be conducted either in person or by telephonic means, whichever best suits the participants and the review.

The timing of reviews should be incorporated into the project design schedule in order to minimize any impact on the schedule. Periods of both review and response by the design team should be included into the project design schedule.

Provide design submittals for review by the peer reviewer(s), organized and documented in a manner that facilitates review by the review panel. Reviewers shall provide written comments in a timely fashion to the Engineer of Record and to the Authority Having Jurisdiction, with requests for action as necessary. The design team is responsible for resolving all comments to the satisfaction of the reviewers.

Commentary: *The review process is driven by submittals by the design team to the peer reviewer(s). Preferably, the submittals and their review should begin with the Basis of Design, which should resolve broad issues about the design approach as well as detailed matters of acceptance criteria. Subsequent review is likely to progress to more detailed results of the design as it proceeds. It is generally considered unfair to the Engineer of Record to bring up new general issues related to the overall design process at later stages of the design, although such matters should be considered where critical to the design's performance capability.*

Most submittals for review are in digital form. However, at certain phases of the design, it may be necessary to submit some materials such as structural drawings in paper form to facilitate the review. After each submittal, good practice is for the design team to convene a meeting with the reviewers in which the design team describes the nature of the submittals and walks through important details. The review team is then given a reasonable time in which to review the submittals and develop comments in a comment log. A meeting to discuss the comments may be appropriate. The Engineer of Record should provide written responses to review comments, with multiple rounds of comment/response sometimes needed for key issues.

Proper documentation of the peer review process is important for incorporation into the project records. It is best to develop a systematic process for establishing, tracking, and resolving comments generated by the peer review. In many cases, this takes on the form of a written spreadsheet that logs all the comments and resolutions, with dates attached. Comments that are discussed and/or any resolutions that are reached during project review

meetings or conference calls should be formally written into the project review comment spreadsheet.

At the conclusion of the review, and at other times requested by the Authority Having Jurisdiction, the peer reviewer(s) shall submit a written report to the Authority Having Jurisdiction documenting the scope of the review, the comment log, and the peer reviewers' professional opinion regarding the general conformance of the design to the requirements of the Basis of Design document.

Commentary: *Some projects may require interim reports from the peer reviewer(s) to facilitate phased permitting. Examples include the excavation permit or the foundation permit. Generally, for such interim reports, the design needs to have progressed sufficiently that the review team is able to state that the permit can be justified on the basis of the work completed to date. The letter should state clearly any caveats regarding the work not yet completed and should clarify that it is the responsibility of the Engineer of Record to provide at a later date any incomplete information necessary to support the requested permit.*

8.5 DESIGN RESPONSIBILITY

The Engineer of Record is solely responsible for the construction contract documents.

Commentary: *It should be noted that the existence of peer review on a project does not relieve the Engineer of Record from any of his/her design responsibility. However, because of the level of complexity incorporated in tall building design, in many cases it is recognized that review of these aspects of the design effectively constitutes the plan review of the seismic system (even though contracts may say that this is not the case). Peer review participation is not intended to replace quality assurance measures ordinarily exercised by the Engineer of Record. Responsibility for the structural design remains solely with the Engineer of Record, as does the burden to demonstrate conformance of the structural design to the intent of the Basis of Design document. The responsibility for conducting plan review resides with the Authority Having Jurisdiction. Third party entities may be hired to assist with the plan review. It can be acceptable for one or more members of the peer review team to assist with plan review under separate contract.*

None of the reports or documents generated by the review are Construction Documents. Under no circumstances should letters or other documents from the review be put into the project drawings or reproduced in any other way that makes review documents appear to be part of the Construction Contract Documents. The Engineer of Record is solely responsible for the Construction Contract Documents. Documents from the peer reviewer(s) should be retained as part of the building department project files.

8.6 DISPUTE RESOLUTION

When disputes between the Engineer of Record and the peer reviewer(s) arise and cannot be resolved as part of the regular review process, resolution of the dispute shall be the responsibility of the Authority Having Jurisdiction. The Authority Having Jurisdiction can provide resolution based on personal knowledge of the situation or, alternatively, may retain other experts to review the material and generate a recommended course of action.

Commentary: *Given the complexity of tall buildings and the performance-based analyses being performed, disagreements occasionally arise between the Engineer of Record and the peer reviewer(s). Generally, these disagreements fall into one of two categories. The first is regarding the level of complexity of analysis/evaluation that has been performed to validate an aspect of the design. In most cases, this should be resolvable with additional analyses, confirming studies, etc. The second case is related to differences of opinion in the interpretation of results, specifically as to whether or not elements of the design criteria have been met. Resolution of such issues may be obtained through sensitivity analyses, bounding analyses, or other means.*

For jurisdictions that have a large number of tall building projects incorporating performance-based design procedures, establishment of an advisory board should be considered. An advisory board should consist of individuals who are widely respected and recognized for their expertise in relevant fields, including, but not limited to, structural engineering, performance-based design, nonlinear analysis techniques, and geotechnical engineering. The advisory board members may be elected to serve for a predetermined period of time on a staggered basis. The advisory board may oversee the design review process across multiple projects periodically, assist the Authority Having Jurisdiction in developing criteria and procedures spanning similar design conditions, and resolve disputes arising under peer review.

8.7 POST-REVIEW REVISION

If substantive changes to the building design occur during project phases subsequent to completion of the peer review, the Engineer of Record shall inform the Authority Having Jurisdiction, describing the changes to the structural design, detailing, or materials. At the discretion of the Authority Having Jurisdiction, such changes may be subject to additional review by the peer reviewer(s) and approval by the Authority Having Jurisdiction.

Commentary: *Because of the fast-track nature of many modern large building projects, it is not unusual for substantive changes to the design to occur during the final stages of the design or construction. It is the responsibility of the Engineer of Record to bring such changes to the attention of the Authority Having Jurisdiction wherever said changes may reasonably be suspected of affecting the performance of the building. Substantive changes include changes in the seismic-force-resisting system configuration, design, detailing, or materials.*

9 References

- Abrahamson N.A., Gregor N., Addo K. (2016). BC Hydro ground motion prediction equations for subduction earthquakes, *Earthq. Spectra*, 32: 23–44.
- Afshari K., Stewart J.P. (2016). Physically parameterized prediction equations for significant duration in active crustal regions, *Earthq. Spectra*, 32: 2057–2081.
- ACI 318 (2014). Building Code Requirements for Structural Concrete (ACI 318-14) and Commentary, American Concrete Institute, Farmington Hills, MI.
- AISC (2006). Steel plate shear walls, *Steel Design Guide 20*, R. Sabelli and M. Bruneau, American Institute of Steel Construction, Inc.
- AISC 341 (2016). *Seismic Provisions for Structural Steel Buildings*, American Institute of Steel Construction, Chicago, IL.
- AISC 360 (2016). *Specification for Structural Steel Buildings*, American Institute of Steel Construction, Chicago, IL.
- Al Atik L., Sitar N. (2010). Seismic earth pressures on cantilever retaining structures, *J. Geotech. Geoenviron. Eng.*, 136, 1324-33.
- Almufti I, Motamed R, Grant D.N., Willford M. (2015). Incorporation of velocity pulses in design ground motions for response history analysis using a probabilistic framework. *Earthq. Spectra*, 31: 1647–1666.
- Ancheta T.D., Darragh R.B., Stewart J.P., Seyhan E., Silva W.J., Chiou B.S.-J., Wooddell K.E., Graves R.W., Kottke A.R., Boore D.M., Kishida T., Donahue J.L. (2014). NGA-West2 database, *Earthq. Spectra*, 30: 989–1005.
- Anderson J.G., Brune J.N. (1999). Probability seismic hazard analysis without the ergodic assumption, *Seismol. Res. Lett.*, 70: 19–28.
- ASCE 7 (2016). Minimum Design Loads for Buildings and Other Structures (ASCE/SEI 7-16), American Society of Civil Engineers, Reston, VA.
- ASCE 41 (2016). *Seismic Rehabilitation of Existing Buildings (ASCE/SEI 41/16)*, American Society of Civil Engineers, Reston, VA, 416 pgs.
- ATC 72 (2010). ATC-72-1: Interim Guidelines on Modeling and Acceptance Criteria for Seismic Design and Analysis of Tall Buildings, Applied Technology Council, Redwood City, CA.
- Bernal D., Döhler M., Kojidi S. M., Kwan K., Liu, Y. (2015). First mode damping ratios for buildings, *Earthq. Spectra*, 31(1): 367–381.
- Bommer J.J., Scherbaum F., Bungum H., Cotton F., Sabetta F., Abrahamson N.A. (2005). On the use of logic trees for ground-motion prediction equations in seismic hazard analysis, *Bull. Seismol. Soc. Am.*, 95: 377–389.
- Boore D.M. (2010). Orientation-independent, non geometric-mean measures of seismic intensity from two horizontal components of motion, *Bull. Seismol. Soc. Am.*, 100: 1830–1835.
- Bournonville M., Dahnke J., Darwin D. (2004). Statistical analysis of the mechanical properties and weight of reinforcing bars,” *SL Report 04-1*, Structural Engineering and Materials Laboratory, The University of Kansas, Lawrence, KS, 198 pgs.

- Bozorgnia Y., Abrahamson N.A., Al Atik L., Ancheta T.D., Atkinson G.M., Baker J.W., Baltay A., Boore D.M., Campbell K.W., Chiou B.S.-J., Darragh R.B., Day S., Donahue J., Graves R.W., Gregor N., Hanks T., Idriss I.M., Kamai R., Kishida T., Kottke A., Mahin S.A., Rezaeian S., Rowshandel B., Seyhan E., Shahi S.K., Shantz T., Silva W.J., Spudich P., Stewart J.P., Watson-Lamprey J., Wooddell K.E., Youngs R.R. (2014). NGA-West 2 research project, *Earthq. Spectra*, 30: 973–987.
- Bozorgnia Y., Campbell K.W. (2016). Ground motion model for the vertical-to-horizontal (V/H) ratios of PGA, PGV, and response spectra, *Earthq. Spectra*, 32: 951–978.
- Brandenberg S.J., Mylonakis G., Stewart J.P. (2015). Kinematic framework for evaluating seismic earth pressures on retaining walls, *J. Geotech. Geoenviron. Eng.*, 141: 04015031
- Brandenberg S.J., Agapaki E., Mylonakis G., Stewart J.P. (2017a). Seismic earth pressures exerted on rigid walls by vertically heterogeneous soil using Winkler method, *Proceedings, 17th World Conf. Earthquake Eng.*, Santiago, Chile, Paper 1755.
- Brandenberg S.J., Stewart J.P., Mylonakis G. (2017b). Influence of wall flexibility on seismic earth pressures in vertically homogeneous soil, *Proceedings, GeoRisk Conference*, Denver, CO, Paper 457.
- Burks L.S., Baker J.W. (2016). A predictive model for fling-step in near-fault ground motions based on recordings and simulations, *Soil Dyn. Earthq. Eng.*, 80: 119–126.
- Chandramohan, R., Baker, J.W., Deierlein, G.G. (2016). Quantifying the influence of ground motion duration on structural collapse capacity using spectrally equivalent records, *Earthq. Spectra*, 32 (2): 927-950.
- Choi H., Ho G., Joseph L., Mathias N. (2012). *Outrigger Design for High-Rise Buildings: An Output of the CTBUH Outrigger Workshop Group*, Council on Tall Buildings and Urban Habitat, Chicago, IL.
- Cruz C., Miranda E. (2016). Evaluation of damping ratios for the seismic analysis of tall Buildings, ASCE, *J. Struct. Eng.*, ASCE, DOI: 10.1061/(ASCE)ST.1943-541X.0001628.
- Donahue J. et al. (2016). Ground motion directivity modelling for seismic hazard applications, PEER report, Pacific Earthquake Engineering Research Center, in preparation, University of California, Berkeley, CA.
- Dreger D.S., Beroza G.C., Day S.M., Goulet C.A., Jordan T.H., Spudich P.A., Stewart J.P. (2015). Validation of the SCEC broadband platform V14.3 simulation methods using pseudospectral acceleration data, *Seismol. Res. Lett.*, 86: 39–47.
- Elkady A., Lignos D.G. (2015). Analytical investigation of the cyclic behavior and plastic hinge formation in deep wide-flange steel beam-columns, *Bull. Earthq. Eng.*, 13(4): 1997-1118.
- Elwood K.J., Eberhard M.O. (2009). Effective stiffness of reinforced concrete columns, *ACI Struct. J.*, 106(4): 476–484.
- Elwood K.J., Matamoros A.B., Wallace J.W., Lehman D.E., Heintz J.A., Mitchell A.D., Moore M.A., Valley M.T., Lowes L.N., Comartin C.D., Moehle J.P. (2007). Update to ASCE/SEI 41 concrete provisions, *Earthq. Spectra*, 23 (3): 493–523.
- Fell B.V., Kanvinde A.M., Deierlein G.G., Myers A.M., Fu X. (2006). Buckling and fracture of concentric braces under inelastic cyclic loading, *SteelTIPS*, Technical Information and Product Service, Structural Steel Educational Council. Moraga, CA.
- Fell B.V. (2008). Large-Scale Testing and Simulation of Earthquake-Induced Ultra Low Cycle Fatigue in Bracing Members Subjected to Cyclic Inelastic Buckling, Ph.D. Dissertation, Department of Civil & Environmental Engineering, University of California, Davis, CA.
- FEMA P58 (2010). *FEMA P58 Next-generation Performance-Based Seismic Design of Buildings*, Federal Emergency Management Agency, Washington, D.C.
- Field E.H., Jordan T.H., Cornell C.A. (2003). OpenSHA: A developing community-modeling environment for seismic hazard analysis, *Seismol. Res. Lett.*, 74: 406–419.

- Goulet C.A., Stewart J.P. (2009). Pitfalls of deterministic application of nonlinear site factors in probabilistic assessment of ground motions, *Earthq. Spectra*, 25: 541–555.
- Griffis L.G. 1993. Serviceability limit states under wind loads, *Eng. J.*,30(1): 1–16.
- Gulerce Z, Abrahamson N.A. (2011). Site-specific design spectra for vertical ground motion, *Earthq. Spectra*, 27: 1023–1047.
- Hamburger R.O., Krawinkler H., Malley J.O., Adan S.M. (2009). Seismic design of steel special moment frames: a guide for practicing engineers, *NEHRP Seismic Design Technical Brief No. 2, NIST GCR 09-917-3*, National Institute of Standards and Technology, Gaithersburg, MD.
- Hayden C.P., Bray J.D., Abrahamson N.A. (2014). Selection of near-fault pulse motions, *J. Geotech. Geoenv. Eng.*, 140: 04014030.
- IBC (2009). *International Building Code*, International Code Council, Washington, DC.
- Jin J., El-Tawil S. (2003). Inelastic cyclic model for steel braces, *ASCE, J. Eng. Mech.*, 129(5): 548–557.
- Kamai R., Abrahamson N.A., Graves R.W. (2014). Adding fling effects to processed ground-motion time histories, *Bull. Seism. Soc. Am.*, 104: 1914–1929.
- Kanvinde A., Grilli D., Zareian F. (2012). Rotational stiffness of exposed column base connections: Experiments and analytical models, *J. Struct. Eng.*, 138(5): 549–560.
- Klemencic R., Fry J.A., Hurtado G., Moehle J.P. (2006). Performance of post-tensioned slab-core wall connections, *PTI J.*, 4(6): 7–23.
- Leyendecker E.V., Hunt R.J., Frankel A.D., Rukstales K.S. (2000). Development of maximum considered earthquake ground motion maps, *Earthq. Spectra*, 16: 21-40.
- McGuire R.K. (2004). *Seismic Hazard and Risk Analysis*, Earthquake Engineering Research Institute Monograph MNO-10, Oakland, CA.
- McGuire R.K., Cornell C.A., Toro G.R. (2005). The case for the mean hazard curve, *Earthq. Spectra*, 21: 879–886.
- McGuire R.K., Silva W.J., Costantino C.J. (2001). Technical basis for revision of regulatory guidance on design ground motions: Hazard-and risk-consistent ground motion spectra guidelines. *NUREG/CR-6728*, U.S. Nuclear Regulatory Commission, Washington, D.C.
- Mikola R.G., Candia G., Sitar N. (2016). Seismic earth pressures on retaining structures and basement walls in cohesionless soils, *J. Geotech. Geoenviron. Eng.*, 142 (10).
- Moehle J.P. (2014). *Seismic Design of Reinforced Concrete Buildings*, McGraw-Hill Education, New York, New York, 760 pgs.
- Moehle J.P., Hooper J.D. (2016). Seismic design of reinforced concrete special moment frames: a guide for practicing engineers (2nd ed.), *NEHRP Seismic Design Technical Brief No. 1, NIST GCR 16-917-40*, National Institute of Standards and Technology, Gaithersburg, MD.
- Moehle J.P., Hooper J.D., Meyer T.R. (2016). Seismic design of cast-in-place concrete diaphragms, chords, and collectors: a guide for practicing engineers (2nd ed.), *NEHRP Seismic Design Technical Brief No. 3, NIST GCR 16-917-42*, National Institute of Standards and Technology, Gaithersburg, MD.
- Motter C.J., Fields D.C., Hooper J.D., Klemencic R., Wallace J.W. (2017). Steel-reinforced concrete coupling beams. II: modeling, *J. Struct. Eng.*, 143(3).
- Naeim F. (2011). Near real-time damage detection and performance evaluation for buildings – A white paper, John A. Martin & Associates, Inc., *Report No. 13115-2011*, Los Angeles, CA.
- Naeim F., Tileyliglu S., Alimoradi A., Stewart J.P. (2008). Impact of foundation modeling on the accuracy of response history analysis of a tall building, *Proceedings, SMIP2008 Seminar on Utilization of Strong Motion Data*, California Strong Motion Instrumentation Program, Sacramento, CA, pp. 19–55.

Naish D., Fry A., Klemencic R., Wallace J.W. (2013). Reinforced concrete coupling beams—Part II: Modeling, *ACI Struct. J.*, 110(6): 1067–1075.

NBS (1980). Development of a Probability Based Load Criterion for American National Standard A58, Building Code Requirements for Minimum Design Loads in Buildings and Other Structures, *NBS Special Publication 577*, National Bureau of Standards, Gaithersburg, MD.

NCHRP (2012). *Practices and Procedures for Site-Specific Evaluations of Earthquake Ground Motions, Synthesis 428* (N. Matasovic and Y.M.A. Hashash), National Cooperative Highway Research Program, Transportation Research Board, Washington D.C.

NIST (2011). *Selecting and Scaling Earthquake Ground Motions for Performing Response History Analysis, NIST/GCR 11-917-15*, prepared by the NEHRP Consultants Joint Venture for the National Institute of Standards and Technology, Gaithersburg, MD.

NIST (2012). *Soil-structure interaction for building structures, NIST GCR 12-917-21*, National Institute of Standards and Technology, U.S. Department of Commerce, Washington D.C.

NIST (2017a). *Guidelines for nonlinear structural analysis for design of buildings, Part I – General*, under preparation by Applied Technology Council, ATC Project 114, pending publication.

NIST (2017b). *Guidelines for nonlinear structural analysis for design of buildings, Part IIa – Steel Moment Frames*, under preparation by Applied Technology Council, ATC Project 114, pending publication.

NIST (2017c). *Guidelines for nonlinear structural analysis for design of buildings, Part IIb – Concrete Moment Frames*, under preparation by Applied Technology Council, ATC Project 114, pending publication.

NIST (2017d). *Recommended Modeling Parameters and Acceptance Criteria for Nonlinear Analysis in Support of Seismic Evaluation, Retrofit and Design*, under preparation by Applied Technology Council, ATC Project 114, pending publication.

Ostadan F. (2005). Seismic soil pressure for building walls—an updated approach, *Soil Dyn. Earthq. Eng.*, 25(7–10), 785–793.

Overby D., Kowalsky M., Seracino R. (2015). A706 Grade 80 reinforcement for seismic applications, *Research Report No. RD-15-15*, Department of Civil, Construction, and Environmental Engineering, North Carolina State University, Raleigh, NC, 114 pgs.

Petersen M.D., Moschetti M.P., Powers P.M., Mueller C.S., Haller K.M., Frankel A.D., Zeng Y., Rezaeian S., Harmsen S.C., Boyd O.S., Field N., Chen R., Rukstales K.S., Luco N., Wheeler R.L., Williams R.A., Olsen A.H. (2014). Documentation for the 2014 update of the United States national seismic hazard maps, *U.S. Geological Survey Open-File Report 2014–1091*, 243 pgs., <http://dx.doi.org/10.333/ofr20141091>.

Pugh J.S., Lowes L.N., Lehman D.E. (2015), Nonlinear line-element modeling of flexural reinforced concrete walls, *Eng. Struct.*, 104: 174–192.

Raghunandan M., Liel A.B. (2013), Effect of ground motion duration on earthquake-induced structural collapse, *Struct. Safety*, 41: 119–133.

Rezaeian S., Bozorgnia Y., Idriss I.M., Abrahamson N.A., Campbell K.W., Silva W.J. (2014a). Damping scaling factors for elastic response spectra for shallow crustal earthquakes in active tectonic regions: “Average” horizontal component, *Earthq. Spectra*, 30: 939–963.

Rezaeian S., Bozorgnia Y., Idriss I.M., Abrahamson N.A., Campbell K.W., Silva W.J. (2014b). Damping scaling factors for vertical elastic response spectra for shallow crustal earthquakes in active tectonic regions, *Earthq. Spectra*, 30: 1335–1358.

Satake N., Suda K., Arakawa T., Sasaki A., Tamura Y. (2003), Damping evaluation using full-scale data of buildings in Japan, *JSCE*, 129(4): 470–77.

Shahi S.K., Baker J.W. (2011). An empirically calibrated framework for including the effects of near-fault directivity in probabilistic seismic hazard analysis, *Bull. Seismol. Soc. Am.*, 101: 742–755.

Shahi S.K., Baker J.W. (2014). NGA-West2 models for ground motion directionality, *Earthq Spectra*, 30: 1285–1300.

Son Vu, N., B. Li, and K. Beyer (2014). “Effective stiffness of reinforced concrete coupling beams,” *Engineering Structures*, 76 (2014), pp. 371-382.

Spudich P, Rowshandel B., Shahi S.K., Baker J.W., Chiou B.S.-J. (2014). Comparison of NGA-West2 directivity models, *Earthq. Spectra*, 30: 1199–1221.

Stewart J.P., Afshari K., Hashash Y.M.A. (2014). Guidelines for performing hazard-consistent one-dimensional ground response analysis for ground motion prediction, *PEER Report 2014/16*, Pacific Earthquake Engineering Research Center, Berkeley, CA.

Stewart, JP, K Afshari, CA Goulet (2017). Non-ergodic site response in seismic hazard analysis, *Earthq. Spectra*. DOI: 10.1193/081716EQS135M.

Stewart J.P., Boore D.M., Seyhan E, Atkinson G.M. (2016). NGA-West2 equations for predicting vertical-component PGA, PGV, and 5%-damped PSA from shallow crustal earthquakes, *Earthq. Spectra*, 32: 1005–1031.

Tran T.A., Motter C.J., Segura, C., Wallace, J.W. (2017). Strength and deformation capacity of shear walls, *Proceedings*, 16th World Conf. on Earthq. Eng., Santiago Chile, Paper No. 2969.

Uriz P. (2005). *Towards Earthquake Resistant Design of Concentrically Braced Steel Structures*, Ph.D. Dissertation, Department of Civil & Environmental Engineering, University of California, Berkeley, CA.

Uriz P., Filippou F.C., Mahin S.A. (2008). Model for cyclic inelastic buckling of steel braces. ASCE, *J. Struct. Eng.*, 134(4): 619–628.

Villalobos E., Pujol S., Moehle J.P. (2016). Panel zones in structural walls, *ACI Special Publication 311* (08).

Vrettos C., Beskos D.E., Triantafyllidis T. (2016). Seismic pressures on rigid cantilever walls retaining elastic continuously non-homogeneous soil: an exact solution, *Soil Dyn. Earthq. Eng.* 82, 142–53.

Watson Lamprey J., Boore D.M. (2007). Beyond S_{aGMRot} : Conversion to S_{aArb} , S_{aSN} , and $S_{aMaxRot}$, *Bull. Seismol. Soc. Am.* 97 1511–1524.

Appendix A. Seismic Instrumentation

A.1 GENERAL

When required by the Authority Having Jurisdiction or desired for other reasons, install seismic instrumentation in buildings in accordance with the provisions of this Appendix.

Commentary: *Installation of seismic instrumentation in tall buildings can have many advantages for the building owners as well as for the advancement of engineering knowledge. The primary advantage for the building owner is that after an earthquake, proper instrumentation can enable rapid determination as to the level of response the building experienced and whether changes in the building dynamic properties, indicative of damage, have occurred. Dense arrays of instrumentation can allow engineers to rapidly identify the locations of damage and calibrate analytical models used to perform post-earthquake analysis and repair damaged areas. Such instrumentation can also facilitate post-earthquake occupancy restriction decisions.*

A.2 INSTRUMENTATION PLAN DOCUMENTATION AND REVIEW

Prepare an instrumentation plan for review by the peer reviewers and approval by the Authority Having Jurisdiction. Include in the plan the number of instruments; their location, and how they are connected to the central recorder; and requirements for installation, maintenance, and dissemination. Incorporate the instrumentation plan as part of the structural drawings.

Commentary: *The instrumentation plan usually is prepared by the Engineer of Record and reviewed by the peer reviewers toward the end of the peer review process after most of the key elements of the building have been determined.*

The instrumentation plan should be incorporated in the structural drawings as a measure of preserving a permanent record of the plan and to provide rapid information to engineers performing future post-earthquake evaluations that the instruments exist. The documentation is particularly important to be maintained because after an earthquake, depending on the level of shaking, it may not be possible to access certain areas in the building until Authorities Having Jurisdiction have scheduled a visit. With good documentation, analysis of the recorded data and assessment of the structural response can occur without accessing the building.

If the building is intended to be included in the inventory of buildings monitored by a government agency, such as the California Geological Survey, the instrumentation should be of a type approved by that agency, and the plan should be coordinated with the agency.

A.3 MINIMUM NUMBER OF CHANNELS

Include at least the minimum number of instrumentation channels indicated in Table A.1. The minimum number of required channels may be increased at the discretion of the peer review team and Authority Having Jurisdiction.

Table A-1 Minimum number of channels of instrumentation.

Number of stories above ground	Minimum number of channels
6–10	12
11–20	15
21–30	21
31–50	24
>50	30

Commentary: *The specified number channels is considered a minimum. For reliable real-time structural health monitoring and performance evaluations, a larger number of channels may be necessary (Naeim, 2011).*

A.4 INSTRUMENT LOCATIONS

Specify a distribution of the instruments throughout the building to facilitate measurement of response quantities that characterize the building’s performance. The instruments shall be connected by dedicated cabling to one or more central recorders, interconnected for common time and triggering, and located in an accessible, protected location with provision for communication.

Commentary: *Strong-motion instrumentation should be located strategically in a building to learn as much as possible about the building’s response during earthquakes and to confirm/verify design and analysis assumptions as well as indicate important modes of response. The following considerations should guide the locations of the instruments.*

1. *It is important is to measure the horizontal and torsional motion on each of a series of floors, from the base to the roof. This requires (at least) three uniaxial horizontal accelerometers at each chosen level. These should be located near the perimeter of the building along walls on opposing sides of the building (as distant as practical from the core) to get the best torsional signal. The sensors placed along the walls should be at the same relative position (e.g., at mid length). They should be oriented with their sensing directions parallel to the walls. A third accelerometer should be placed near the center of the floor, oriented perpendicular to the other two, to measure horizontal motion in that direction.*
2. *For buildings that are relatively regular over their height, the instrumented levels should be evenly distributed over the building’s height. For buildings with changes in the structural system or mass over height, the even distribution might be adjusted to enable measurements near the elevation(s) where these changes occur.*
3. *To measure potential rocking or uplift at the base, at least two vertical accelerometers are needed, placed near walls on the opposing sides of the building. To measure rocking in both directions, a third accelerometer is needed near one of the other walls. In general, the upper floors do not need vertical accelerometers.*
4. *For easy interpretation and analysis of the recorded data, sensors on different floors should be stacked vertically, that is, placed at the same relative position on each floor, such that the same location in the response is measured.*

5. *Consider placing additional sensors to measure response of special features near the roof, such as mechanical equipment in the penthouse or architectural features with mass.*
6. *It may be effective to install sensors in the interstitial space above a false ceiling if present. This keeps the sensors out of the way of the occupants and normal building activities, reducing likelihood of damage to the sensor. Thus, sensors planned to measure the motion of a floor would be located on the underside of the floor, above the ceiling of the story below.*
7. *The central recorder should be in a utility or electrical room with AC available, on one of the lower floors of the building, for convenience. Generally, a communication line (phone line or Internet) should be provided at the recorder location.*
8. *Cabling from the accelerometers to the recorder should be continuous runs (i.e., no splices). A pathway will need to be established for the vertical run from the sensors on the upper floors to the recorder location. Depending on local ordinances and fire codes, plenum-rated cable may be required.*

A.5 INSTALLATION AND MAINTENANCE

The building owner shall install and maintain the instrumentation system.

Commentary: *The locations and orientations of the instruments should be in accordance with the locations shown on the structural drawings. Photographs should document the original instrumentation placement. A tag should be attached at each sensor location to underscore its importance. Nonetheless, given the infrequent occurrence of strong earthquake shaking, it is possible that some instruments will be moved to accommodate ongoing activities in the building. When this happens, the new locations and orientations should be documented and recorded with photographs.*

The tag attached at each sensor location can read, for example, “Seismic sensor - Do not remove without notifying Authority Having Jurisdiction.”

A.6 DATA DISSEMINATION

The instrumentation plan should include the plan for dissemination of data as necessary.

Appendix B. Basis of Design

B.1 GENERAL

Prepare a formal Basis of Design document that describes the intended structural and nonstructural systems, performance objectives, any intended deviations from prescriptive building code criteria, and the specific loading, analysis, design procedures, and acceptance criteria to be employed in the design. Prepare the initial draft of the Basis of Design as early in the design process as is practical, and update and revise this document as the design is advanced and the details of the building characteristics and performance are better understood.

Commentary: Clear and concise communication of building design intent through a well-prepared Basis of Design document is beneficial for all parties involved in building design, review, and implementation. Within the structural engineer's office, staff members will benefit from consistent and clear direction promoting a well-executed design. Building officials faced with review of the design will gain a clear understanding of how the design is intended to meet or exceed the performance expectations inherent in the building code. Peer reviewers, responsible for completing in-depth review of the design, will benefit from a thorough summary of the design objectives, methods of analysis, and acceptance criteria.

Submit the Basis of Design to the peer reviewers and building official for acceptance well in advance of the submittal of documents for building permits.

Commentary: It is important to obtain agreement regarding the proposed design approach as early in the process as is practical in order to avoid expending needless effort using an approach that will not receive approval. Once agreement on the design approach is reached, it should be possible to obtain approval simply by demonstrating that the design conforms to the agreed upon criteria. It should be noted, however, that as the details of a design are developed, it may become necessary to revise the previously anticipated design approach, analytic procedures, and/or proposed acceptance criteria. Multiple submissions of the Basis of Design, as it evolves, may be necessary and should be anticipated by all project participants.

B.2 CONTENT

The following sections indicate the suggested content for project Basis of Design documents and the types of information that generally should be included.

B.2.1 BUILDING DESCRIPTION AND LOCATION

Commentary: The purpose of this section is to provide a basic understanding of the project scope and a framework that will place in perspective the specific procedures and criteria that follow in subsequent sections.

a. General

Provide a brief description of the overall building, including any special or unique features and occupancies. This description should include a characterization of the site, its geographic coordinates, and the underlying site conditions.

b. Description of Seismic and Wind Force-Resisting Systems

Provide a brief description of the seismic and wind force-resisting systems. This discussion should include a description of the primary load paths, the anticipated areas of inelastic behavior, and any response modification devices (isolation bearings, passive or active damping, or other) that will be incorporated into the design.

c. Representative Drawings

Provide sufficient floor plans, building sections, and elevations to provide an overview of the building. Drawings should clearly identify the configuration of the primary lateral-force-resisting system.

B.2.2 CODES AND REFERENCES

a. Controlling Codes, Standards, and Other References

Provide a listing of the controlling building codes, including local amendments, and any standards, guidelines, or reference documents upon which the design will be based.

b. Exceptions to Building Code Provisions

Provide a listing of any exceptions or deviations that will be taken from the prescriptive building code provisions, together with a brief description of the justification for such exceptions.

***Commentary:** Most buildings designed in accordance with these Guidelines will generally conform to the design and construction requirements of the applicable building code, with the exception that a limited number of exceptions or alternative criteria will be employed. Because all of the prescriptive requirements of the building code are presumed to be important to the building performance, the structural engineer should indicate why non-compliance with any of these criteria will be acceptable for this particular design. Reasons provided could include identification that the requirement is not applicable to the particular building in one or more ways, or that acceptable performance will be assured by other means, such as analysis or testing.*

B.2.3 PERFORMANCE OBJECTIVES

Provide a listing of the expected building performance objectives including the structural and nonstructural components. These objectives should address performance under both SLE and MCE_R hazards. A listing of some of the possible components includes:

- Overall Building Performance
- Performance of Structural Elements
 - Walls
 - Columns
 - Beams
 - Braces

- Floor Slabs
- Diaphragms
- Foundations
- Damping Devices
- Performance of Nonstructural Elements
 - Cladding
 - Partition Systems
 - Elevators
 - Exit Stairs

Commentary: *Tabular summary of the performance objectives for each of the important building components at both SLE and MCE_R shaking level is recommended. Include discussion of intended seismic-force-resisting elements and gravity elements.*

B.2.4 GRAVITY LOADING CRITERIA

Provide a description of gravity-loading criteria, including allowances for key structural and nonstructural components, and live loading to be applied in different portions of the building. Specify any live-load reductions to be employed as well as any special loads including vehicular or special equipment.

B.2.5 SEISMIC HAZARDS

Provide a brief summary of the seismic demands to be considered during design including SLE and MCE_R shaking as well as any other shaking levels that may be selected. The site characterization and definition of specific seismic demands will likely be more thoroughly addressed in a separate report prepared by a seismic ground motion specialist. The purpose of this section is to briefly summarize important details regarding the seismic hazard that will influence the structural design. This section should, as a minimum, include:

- Site Class per the building code
- Likelihood of seismic hazards other than ground shaking, including liquefaction, land sliding, lateral spreading, or inundation
- Return periods (or annual frequencies of exceedance) and the deterministic or characteristic events that define both the SLE and MCE_R shaking
- Elastic acceleration response spectra for the SLE and MCE_R shaking
- Acceleration histories that will be used for nonlinear dynamic analysis, including a discussion of the specific earthquakes, their magnitudes, and the recordings used; distances to the instrument and orientation of fault rupture relative to the instrument; and adjustment (scaling/matching) procedures employed. If amplitude scaling is performed, identify the scale factors used. Provide plots that illustrate the extent to which the individual adjusted records and their average compare with the target design spectra. If spectral matching is used, identify the procedures used to perform such matching.

Include the detailed Site-Specific Seismic Hazard report as an appendix.

Commentary: *It is important that the response spectra and corresponding ground motions to be used in analysis are reviewed and approved by the peer review prior to completing the analytical work.*

Rather than incorporating detailed information on the selection and scaling of acceleration histories in the Basis of Design, it may be preferable to incorporate this information by reference to the project Geotechnical/Seismic Hazards Investigation report.

B.2.6 WIND DEMANDS

Where the Building Official requests that the peer review include evaluation of the wind design, provide a brief summary of the wind demands that will be considered during design including:

- Design wind speed and return period (or annual frequency of exceedance) to be used for strength considerations
- Design wind speed and return period (or annual frequency of exceedance) to be used for service-level considerations
- Site exposure characteristics
- Method used to determine wind loadings (analytical or test)

If a wind tunnel test is performed, include the detailed wind tunnel report as an appendix.

Commentary: *Some jurisdictions exclude wind evaluation from peer review scope. These contents are only relevant when wind design is included in the peer review scope.*

Even in regions of very high seismic risk, it is possible for wind demands to exceed service-level shaking demands or, for some elements, even MCE_R shaking demands. In addition, wind-induced overturning moments may exceed seismic overturning moments when defining the lower-bound strength of the structural system. Wind effects should be evaluated early in the design process.

B.2.7 LOAD COMBINATIONS

Provide a summary of all design load combinations that will be used and the specific elements to which they will be applied. Refer to Chapters 5 and 6 for further guidance on load combinations.

Commentary: *It is likely that a series of different load combinations will be used for different elements. For example, adequacy of foundations will typically be evaluated using Allowable Stress load combinations. Load and Resistance Factor combinations will typically be used for dead, live, wind, and seismic demands on structural steel and reinforced concrete elements. Different load combinations may be used for elements that are intended to exhibit inelastic behavior as opposed to those elements that are intended to remain elastic. Service-Level Earthquake load combinations may be different from those used for MCE_R response. Also, the treatment of floor live loading may be different in the various load cases. It is important to identify the specific application for each load combination presented.*

B.2.8 MATERIALS

Provide a list of the material properties to be specified on the design drawings, as well as any assumptions regarding material over-strengths or lower-bound strengths to be used in the design evaluations.

Commentary: *Expected material properties will be used in developing mathematical models of the structure in an attempt to characterize the expected performance as closely as possible. These same material properties will also likely be used in implementing capacity design concepts and evaluating demand/capacity ratios of elements with benign modes of failure. Lower-bound strengths are likely to be used in demand/capacity assessments of elements with brittle failure modes or modes that can result in catastrophic consequences.*

B.2.9 ANALYSIS

a. Procedures

Provide a summary of each method of analysis (linear static, linear dynamic, nonlinear static, and/or nonlinear response history) that will be used and the anticipated application and purpose of each of these.

b. Analysis and Design Software

Provide a listing of the various analysis and design tools (software) being used, including the specific version of this software.

c. Modeling Procedures and Assumptions

Provide a summary of the modeling procedures and key assumptions to be incorporated in each evaluation including:

- Material properties
- Section property definition
- Joint stiffness assumptions
- Damping assumptions
- Component models and hysteretic behavior
- Boundary conditions

Commentary: *Many designs will incorporate different models and analysis procedures for the SLE and MCE_R shaking evaluations. Some designs may also incorporate an evaluation of elements for DE shaking, as identified in the building code. The Design Criteria should separately and completely describe the modeling approach and assumptions used for each analysis employed.*

B.2.10 ACCEPTANCE CRITERIA

Provide a summary of all acceptance criteria to be used in demonstrating that the design meets or exceeds the stated performance objectives for both SLE and MCE_R shaking. Include details regarding:

- Strength calculations

- Demand/capacity ratios
- Drift limits
- Deformation limits
- Strain limits

For demands obtained from nonlinear dynamic analyses, indicate the statistical quantities from the suite of analysis results that will be used to perform evaluations against the acceptance criteria. Refer to Chapter 8 for further guidance on this subject.

Where strain limits will be used as acceptance criteria, describe specifically how predicted strains will be derived from the analysis.

In addition, show representative details necessary to justify the acceptance criteria. Examples include:

- Concrete confinement details
- Slab–column connection details
- Slab–wall connection details
- Moment-frame connection details
- Brace connection details
- Collector details
- Damping-device details

Commentary: *Acceptance criteria are the acceptable values of the various response quantities obtained from the analysis. They can include limits on element force demands, element inelastic deformation demands, and global parameters such as drift. Where nonlinear dynamic analysis is performed using suites of ground motions, a suite of demands will be obtained for each of these response quantities. It is not unusual for the coefficient of variation for the values of individual response quantities to range as high as 50%. While it may be appropriate to use mean or average demands for response quantities associated with the prediction of failure modes that have relatively benign consequences, it is usually appropriate to use more conservative estimates of demand for behavioral modes that can result in catastrophic consequences. Chapters 5 and 6 recommend acceptance criteria for different types of elements associated with their several behavioral modes.*

B.2.11 TEST DATA TO SUPPORT NEW COMPONENTS, MODELS, AND SOFTWARE

If the design includes innovative components, materials, modeling techniques, or software, include supporting materials justifying their appropriateness. Where laboratory testing is used as a benchmark for such justification, provide explicit references to publications documenting the tests if they are in the public domain or include copies of test reports in an appendix to the report if the information is not publicly available.

B.2.12 APPENDICES

Include the following materials in appendices, as appropriate.

- Geotechnical Report
- Site-Specific Seismic Hazard Report

- Wind Tunnel Report
- Research Papers

Appendix C. Design-Earthquake Evaluation

C.1 GENERAL

ASCE 7-16 includes several seismic design procedures, including linear methods, encompassed in ASCE 7 Chapter 12, and a nonlinear method encompassed in ASCE 7 Chapter 16. The Chapter 16 nonlinear procedures, which, like these Guidelines, explicitly evaluate nonlinear dynamic response for MCE_R shaking levels, also require evaluation of the structure for the requirements of Chapter 12, with a few exceptions. Chapter 12 specifies seismic design for a Design Earthquake (DE) shaking level defined as having two-thirds of the intensity of MCE_R shaking. The design follows elastic procedures with forces reduced by a structural system-dependent factor R from those that would be experienced by a structure responding elastically to the specified shaking. The R values have been set based on historic precedence and judgment of the developers of ASCE 7. Structures designed using the prescriptive ASCE 7 provisions are expected both to provide minimum acceptable levels of protection against collapse for MCE_R shaking as well as protection against damage in relatively frequent, lower-intensity earthquakes.

These Guidelines refer to the ASCE 7-16 requirements for many details of the design process, including selection and modification of ground motions and nonlinear response history analysis (Chapter 16). However, these Guidelines also recommend several exceptions and modifications to the ASCE 7 requirements, including the acceptance criteria for evaluating MCE_R response. Another important exception taken by these Guidelines is that, rather than requiring an elastic seismic evaluation of the structure in accordance with ASCE 7 Chapter 12, these Guidelines instead recommend performance evaluation for a moderate level of motion, termed SLE, with a goal of limited damage. Although compliance with the prescriptive requirements of ASCE 7 Chapter 12 is not specifically required by these Guidelines, the Authority Having Jurisdiction might still require such compliance, although permitting some exceptions to be taken to the procedures when approved by the peer reviewer(s). This Appendix suggests guidelines for use in conforming to those criteria where the Authority Having Jurisdiction requires it.

C.2 EXCEPTIONS

It is permissible to take exceptions to the requirements of ASCE 7 Chapter 12 if approved by the peer reviewer(s) and the Authority Having Jurisdiction. The following sections suggest reasonable exceptions. Additional exceptions may be appropriate for individual projects.

C.3 GROUND MOTION

Determine the DE response spectrum using either the general procedures of ASCE 7 Chapter 11 or the site-specific procedures of ASCE 7 Chapter 21, as permitted by the ASCE 7.

Commentary: *Since the Chapter 12 evaluation is performed at a somewhat arbitrary level (two-thirds of MCE_R shaking, reduced by an R value) and under these Guidelines both serviceability for a defined hazard level and collapse resistance for MCE_R shaking are explicitly evaluated, it is not necessary to use the site-specific design earthquake spectra for Chapter 12 evaluations.*

C.4 R , C_d , Ω_o , AND ρ FACTORS

Use R factors selected from Table C-1 unless otherwise approved by the peer reviewer(s) and the Authority Having Jurisdiction.

Table C-1 Recommended values of R factors.

System Description	R
Systems with well-distributed zones of yielding, proportioned using principles of capacity design and with yielding occurring primarily in elements capable of local ductility of 4 or more without loss of more than 20% of peak load-carrying capacity	8
Bearing wall systems and coupled bearing wall systems meeting the detailing requirements of ACI 318 for Special Reinforced Concrete Shear Walls	6
Other Systems	*

* R factors for other systems should be taken as specified in ASCE 7, unless specifically justified to and approved by the peer reviewer(s) and the Authority having jurisdiction

Commentary: Systems such as special steel, concrete, and composite moment-resisting frames and steel or composite eccentric-braced frames generally meet the criteria described for an R factor of 8. Buckling-restrained braced frames that are proportioned so as to ensure distributed yielding throughout the height of the structure may also qualify for this criterion.

Special reinforced concrete shear walls in tall buildings have commonly been proportioned using an R value of 6 and have been demonstrated through nonlinear analysis to be capable of acceptable behavior at MCE_R shaking. Use of the code-specified R value of 5 can increase shear demands on the walls, relative to that of structures designed for an R value of 6, without providing other obvious performance benefit. Therefore, these Guidelines recommend continued use of an R value of 6 for such structures when the DE design is performed.

The value of the redundancy coefficient ρ may be taken as unity. Values of the C_d and Ω_o coefficients are not required under ASCE 7 Section 16.1.2.

Commentary: The value of the redundancy coefficient, ρ , has commonly been taken as unity in the design of tall buildings using performance-based procedures because more rigorous evaluation of performance at the MCE_R shaking level obviates the need for this factor. These Guidelines recommend continuation of this practice.

ASCE 7-16 does not require evaluation of drift for DE shaking when nonlinear analysis in accordance with Chapter 16 is performed. The standard also exempts the elastic design evaluations from having to evaluate load combinations using the Ω_o coefficient because the MCE_R evaluation is a more rigorous evaluation of elements subject to those load combinations. Therefore, values of the C_d and Ω_o coefficients are not needed.

C.5 REDISTRIBUTION OF COUPLING BEAM FORCES

Any reasonable assumptions regarding stiffness of coupling beams in shear wall structures, or redistribution of computed DE forces in coupling beams in shear wall structures, may be made, subject to verification of system performance in the MCE_R evaluation.

Appendix D. Preliminary Design

D.1 GENERAL

The growing body of experience resulting from the design of tall buildings using performance-based procedures provides much insight that can be used to guide the preliminary design process. This chapter provides a resource, highlighting important topics shown by experience as critical to consider early in the design process.

D.2 SYSTEM CONFIGURATION

To the extent possible, configure the structure to include a simple arrangement of structural elements with clearly defined load paths and regular structural systems. Configurations and geometries that complicate behavior and add to complexity of analysis and uncertainty should be avoided where practicable. These include:

- Large changes in building stiffness (Figure D-1)
- Large changes in building mass (Figure D-1)
- Repositioning of bracing elements from floor to floor (Figure D-2)
- Interaction of two or more towers through a common base structure (Figure D-3); see discussion in Section D.3
- Significant column transfers or offsets (Figure D-4)
- Gravity-induced horizontal shear forces caused by system eccentricities (Figure D-5)
- Limited connectivity of bracing elements to floor diaphragms (Figure D-6)

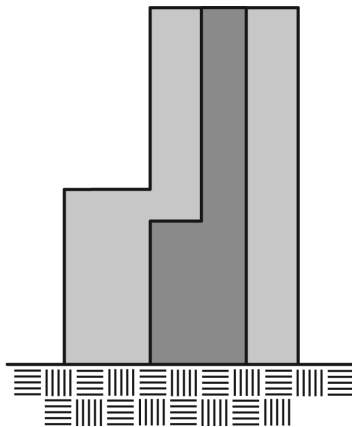

Figure D-1 Large changes in stiffness and mass.

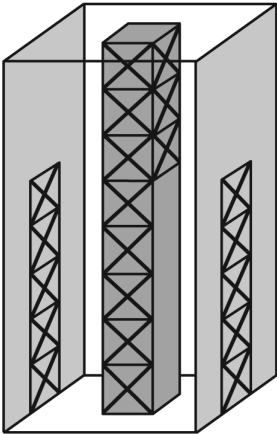

Figure D-2 Lateral system with bracing elements repositioned over height.

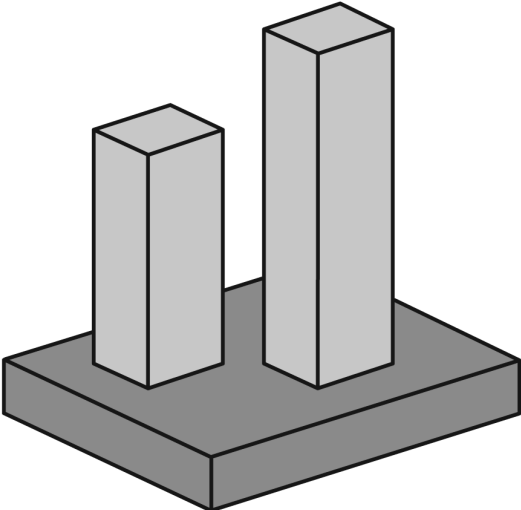

Figure D-3 Two towers on a common base.

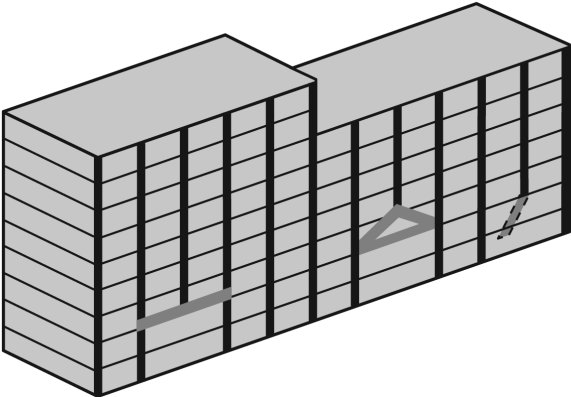

Figure D-4 Column transfer and offset conditions.

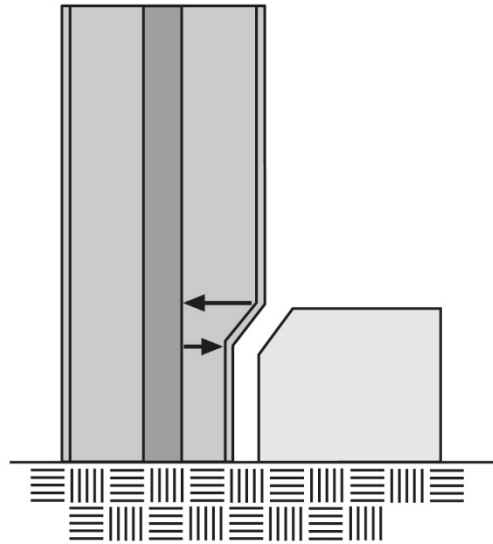

Figure D-5 Building geometry resulting in gravity-induced shear forces.

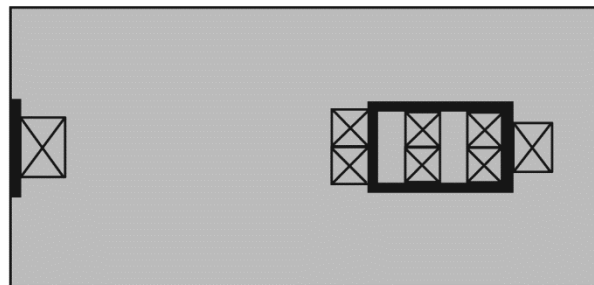

Figure D-6 Diaphragms with limited connectivity to vertical seismic-force-resisting elements.

Commentary: Avoidance of the conditions discussed above will simplify analysis and allow for a greater degree of confidence in evaluating system behavior. The assumptions inherent in any mathematical structural model add to the uncertainty in evaluating behavior. Some of these uncertainties can be eliminated through a simple, well-conceived geometry, thus reducing the analytic studies required to test and prove system behavior.

A regular, well-defined system may seem irreconcilable with modern architectural expression. However, a disciplined approach to the architectural design of a tall building, incorporating important structural principles, will generally lead to the most well-behaved and economical structure.

This list of irregularities described is by no means comprehensive, nor can these items be avoided in all buildings. As a structure becomes more complex, the uncertainty in evaluating its response escalates, requiring more robust analytic work to adequately test and demonstrate performance.

D.3 MULTIPLE TOWERS ON A COMMON PODIUM

One of the more common design occurrences is multiple towers on a common podium. Many times, one or more of the structures are designed using the code-prescriptive requirements, resulting in a challenge of combining transfer demands at the podium level with the performance-based tower. Alternative approaches to evaluate the transfer demands include:

1. Model the towers separately. The code-prescriptive model does not include the podium, but the performance-based design (PBD) tower does. Algebraically sum (or subtract) the code-prescriptive forces, factored by Ω_0 , to the design actions obtained from the nonlinear analysis.
2. Model the towers on a common podium and perform the nonlinear analysis.

Concerns with the second approach include:

1. The Engineer of Record for the PBD tower is not always the Engineer of Record for the entire project, and may not have sufficient information to model the code-prescriptive tower; and
2. Nonlinear analysis of the code-prescriptive tower may provide information that the performance of the building is undesirable, despite conformance with the building code prescriptive provisions.

Despite these concerns, these Guidelines recommend the second approach. The model of the code-prescriptive tower can be simplified substantially. As an example, an elastic or elastic-plastic “lollipop” could be used to minimize the amount of processing time and information obtained on the code-prescriptive tower.

Cases where the first approach may be adequate include:

- The code-prescriptive building is relatively short (less than 65 feet) and has limited influence on the PBD tower
- The code-prescriptive building consists of light-framed construction

D.4 STRUCTURAL PERFORMANCE HIERARCHY

As the structural concept for a tall building is being developed, clearly identify zones or elements where nonlinear response is anticipated. Capacity design concepts are a good starting point when considering desirable system and element actions. While a strict application of capacity design may not be practical or even warranted in the final design, early consideration of these principles will help establish a clear hierarchy of the anticipated building response and will serve to guide the development of the design, which will later be confirmed through nonlinear response history analysis.

A primary aim of the preliminary design should be to select a target yielding mechanism that is practical within the ductility limits of available structural components. For frame or braced-frame structures, yielding that is well distributed over the height is preferred to yielding that is concentrated in one or few stories. For core-wall structures, a targeted flexural yielding mechanism that distributes flexural yielding over the lower stories just above a podium may be acceptable.

Another aim of the preliminary design is to target yielding to occur in components that are reliably capable of ductile response. Desirable modes of inelastic response include, but are not necessarily limited to, the following:

- Flexural yielding of beams in special moment frames
- Flexural yielding in reinforced concrete beams, slabs, shear (structural) walls, and conventionally reinforced coupling beams with relatively slender proportions
- Yielding of diagonal reinforcement in diagonally reinforced concrete coupling beams
- Tension yielding in structural steel braces and steel plate shear walls, and tension/compression yielding in buckling-restrained braces
- Post-buckling compression in structural steel braces that are not essential parts of the gravity load system, and whose buckling does not compromise system behavior
- Shear yielding in structural steel components such as panel zones in moment frames, shear links in eccentric braced frames, and steel coupling beams
- Yielding of outrigger elements, while protecting the axial-load-resisting capacity of gravity-load-carrying outrigger columns
- Yielding in ductile fuses or energy dissipation devices
- Controlled rocking of foundations

Where designs require yielding in components such as gravity-load-carrying columns, e.g., at the intersection of a frame column with a basement wall or a frame column with roof beams, the design should provide details, possibly beyond the minimum requirements of the building code, that ensure adequate behavior at such yielding locations. These yielding locations should be brought to the attention of the structural peer reviewer(s) so that they can be adequately considered early in the review process.

Commentary: *Identification of zones of inelastic response will provide clarity in the overall design approach and the ensuing analytic work. In addition, contemplating the hierarchy of likely response actions to increasing levels of ground motion will provide direction to guide the details of the design to follow.*

Capacity-design approaches provide a useful means to configure a structure to produce predictable inelastic behavior. However, the higher-mode response common in tall buildings can lead to inelastic behavior in zones that simplistic approaches to capacity design will be unable to predict. Ultimately, engineers must rely on analytical verification of behavior to detect any additional zones of inelastic behavior other than those suggested by initial capacity design proportioning of the structure.

As noted in Section D.5, the overall strength of the lateral-force-resisting system may be controlled by wind demands. In such cases, using a yielding hierarchy approach (e.g., coupling beams followed by wall hinging), along with the requisite detailing, is a more reasonable approach than a strict capacity-based approach.

D.5 WIND

Ensure that the lateral-force-resisting system is adequate for wind resistance considering both strength and serviceability criteria.

Commentary: *While these Guidelines focuses primarily on seismic design, it is important to remember that structural response to wind effects may control the strength and stiffness requirements for tall buildings. Many times, occupant comfort related to building accelerations in wind events is the controlling design criterion, directly influencing the required building stiffness to appropriately manage these actions.*

The overall strength of the lateral-force-resisting system may be controlled by wind demands. Wind overturning moments and shears in most tall buildings are more closely related to first-mode dynamic response, whereas seismic overturning moments and shears can be heavily influenced by higher dynamic modes of vibration. The net result can be substantially higher wind demands as compared to seismic demands at the base of a tall building, whereas seismic demands may find their peak at the mid-height of the tower.

Wind tunnel studies that model the dynamic actions of a tall building within the context of its surroundings may be important to efficient wind design.

D.6 HIGHER-MODE EFFECTS

Consider the potential effects of higher-mode response when proportioning the main seismic-force-resisting system.

Commentary: *It is common for higher dynamic modes of vibration to heavily influence tall building response to ground shaking. Traditional engineering practice has focused strictly on the first translational mode when setting strength requirements and lateral force distributions. For tall buildings, the second or even third mode of vibration can be equally, if not more, important to the overall design.*

As illustrated in Figure D-7, the influence of these higher modes of vibration can result in significantly higher flexural demands well above the base of a building, as well as shear demands three to four times greater than those anticipated by a typical prescriptive design. Failing to recognize and incorporate these demands into a design can lead to undesirable performance at worst and the need to iterate nonlinear analyses and redesign several times at best.

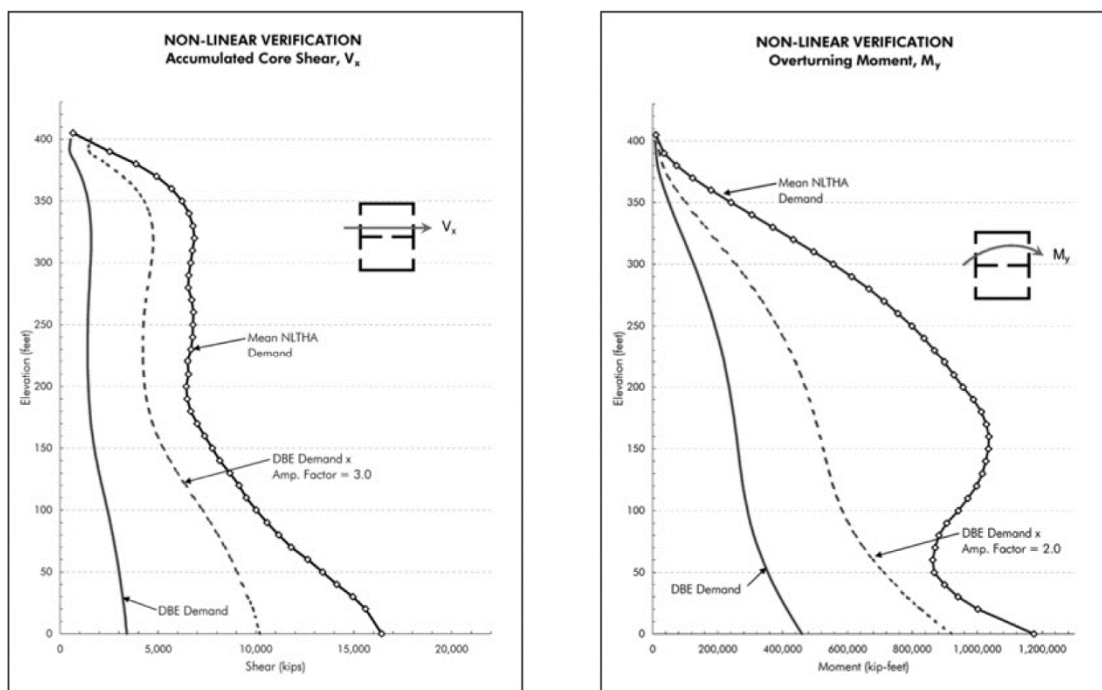

Figure D-7 Higher-mode effects on demand distributions in a tall core-wall building.

D.7 SEISMIC SHEAR DEMANDS

Consider limiting shear stress demands in concrete walls under SLE seismic forces to the range of $2\sqrt{f'_c}$ to $3\sqrt{f'_c}$ where f'_c is the specified concrete compressive strength in pounds per square inch.

Commentary: As noted in the previous section, the dynamic behavior of high-rise buildings can lead to very high shear demands from higher-mode effects. Experience has shown that limiting SLE shear stresses in concrete walls to the range of $2\sqrt{f'_c}$ to $3\sqrt{f'_c}$ will generally result in MCE_R shear demands that fall within maximum allowable shear stress limits.

D.8 BUILDING DEFORMATIONS

Consider limiting roof displacement determined by elastic response spectrum analysis under MCE_R shaking to less than 3% of building height.

Commentary: Evaluation of overall building deformations at the preliminary design stage offers insight, however limited, into the anticipated behavior considering MCE_R demands. Maximum building displacements in the range of 2% to 3% of overall height are generally viewed as acceptable for protecting against global instability under MCE_R shaking. The dynamic characteristics of tall buildings are such that median values of total inelastic displacement are reasonably well estimated by elastic spectral analysis as long as the structure is not displaced to deformations near those associated with instability.

Story deformation is a more complex action to evaluate. While traditional design practice has focused purely on translational movements, actions in tall buildings related to shear

deformation as opposed to total deformation can be equally important. Griffis (1993) provides greater insight on this topic. Story deformations and their impact on architectural finishes are the key design parameters to consider.

D.9 SETBACKS AND OFFSETS

Attempt to avoid setbacks and offsets in the lateral-force-resisting system. Where such geometric configurations are unavoidable due to architectural considerations, consider the provision of supplemental strength and/or detailing for ductile behavior in the areas of these conditions.

Commentary: *Setbacks in overall building geometry or offsets in lateral-bracing elements generally lead to a concentration of demands. Care should be taken in these areas during preliminary design to allow for adequate member sizing, anticipating robust detailing requirements in the final design.*

Setbacks in concrete core walls or lateral bracing can result in a high concentration of strain demands through the geometry transition. The potential results include localized yielding of structural elements and the need for robust concrete confinement and/or steel detailing.

Offsets in bracing systems can also result in significant diaphragm demands. Due consideration of the stiffness degradation of these transfer diaphragms as well as the details of structural collector and/or chord elements will be required during later stages of the design process.

D.10 DIAPHRAGM DEMANDS

Pay careful attention to the configuration and strength of diaphragms at transitions in the lateral-force-resisting system.

Commentary: *Diaphragm demands on the floor systems of typical high-rise floors are generally nominal, unless the given floor configuration is long and slender with widely spaced bracing elements or includes offsets in the primary lateral bracing system.*

Diaphragm demands at transitions in building geometry (such as a podium structure) or at the base of a building can be extraordinary and warrant special attention early in the design process. Large shear reversals (backstay forces) may be identified by the structural analyses. If these load paths are to be realized, limitations on diaphragm openings and offsets may be required. These requirements can be particularly onerous at the ground level of a building where garage entry ramps, loading docks, retail spaces, and landscaping design often result in geometrically complex floors. Early coordination with the architect is imperative to ensure that adequate load paths will exist in the completed structure. For additional discussion, see Moehle et al. (2016).

D.11 OUTRIGGER SYSTEMS

Outrigger systems are often included in high-rise building designs to reduce overturning demands on slender vertical elements of the lateral-force-resisting system (Figure D.8). It is important to consider the impact of the outriggers on the supporting columns and walls under maximum demand levels. For example, an outrigger supported by a perimeter column may be capable of delivering an axial force much greater than traditionally considered. Evaluating the

over-strength characteristics of an outrigger system, and the potential impacts on axial and shear demands is critical to ensuring that the overall building system will perform as expected.

Commentary: *Properly proportioning outrigger systems is quite complex. The interaction of the outrigger systems with the lateral-force-resisting system needs to be evaluated at various demand levels (SLE, Wind, and MCE_R) and, depending on the intended performance at each level, it is not always obvious which will govern the design. Guidance for proportioning outrigger systems can be found in the literature, including the CTBUH Outrigger Design Guide (2012).*

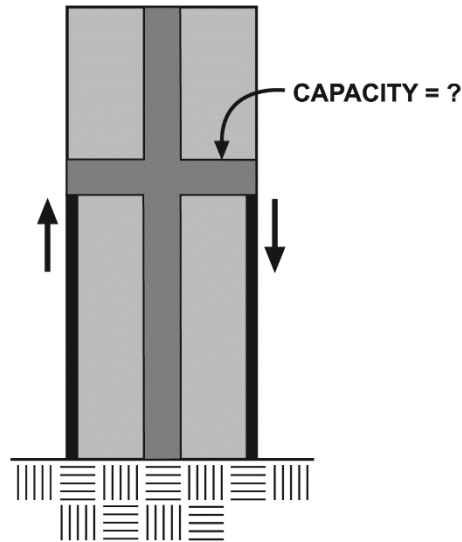

Figure D-8 Illustration of outriggers used to reduce overturning demands at base of vertical elements of the seismic-force-resisting system.

D.12 NON-PARTICIPATING ELEMENTS

Consider the impacts of all building elements on the ultimate behavior and element demands. In addition to providing for deformation compatibility of gravity-load-resisting elements, consider that axial and shear demands on columns and walls can be significantly influenced by interaction with “gravity framing.”

Commentary: *Traditional seismic design practice has assigned primary bracing requirements to a few select elements, while the remaining features of the structure have been deemed as “non-participating elements.” This is merely a simplification of the real building actions. Elements intended only to provide gravity resistance can greatly influence the behavior of the main lateral-force-resisting system and also attract substantial earthquake-induced stresses themselves.*

D.13 FOUNDATIONS

The subject of soil–foundation–structure interaction is complex and often neglected in the design process. Due consideration should be given to the uncertainties related to soil–structure interaction. Traditional practice has input seismic ground motions to structural analysis models at the ground surface in the form of free-field motions. Many times, tall buildings have significant

substructures that may play an important role in overall building behavior. A well-considered approach to this topic should be developed during the preliminary design stage. Bounding the response of the structure by varying the foundation support assumptions may be a practical way to address this complex issue. Section 4.5 provides more detailed discussion.

D.14 SLAB–WALL CONNECTIONS

In buildings supported in whole or part by concrete core walls, the integrity of the connection between the floor slabs and core walls is an important consideration. As a tower sways due to wind or earthquake-induced motion, the slab–wall connections may be subjected to significant rotations. The rotations are increased by vertical motions associated with elongation and shortening of the core wall over its height as a result of flexural action. Klemencic et al. (2006) discusses this action and presents details that were found to produce acceptable behavior under MCE_R -level drifts and rotations.

D.15 SLAB–COLUMN CONNECTIONS

Robust detailing of slab–column connections in slab–column systems is important to the integrity of tall concrete buildings. As slab–column connections experience lateral deformations, increased moment and shear demands result. These demands may result in yielding of slab reinforcing steel. More critical is the increased shear demand. Robust details that address/prevent punching shear failure at MCE_R -level drifts and rotations are essential.

Commentary: *While there are other guidelines that provide design information for the performance of slab–column connections, the authors recommend that ACI 318 is the appropriate guideline to be used to design connections.*

Appendix E. Typical Force-Controlled Actions and Categories

In these Guidelines, member actions are classified as either deformation-controlled or force-controlled. In addition, Chapter 6 requires force-controlled actions to be further classified in different categories of criticality. Table E-1 identifies typical force-controlled actions and categories.

Table E-1 Force-controlled actions and categories

Action		Category		
		Critical	Ordinary	Non-critical
Structural Steel	Connections of braces to beams, columns and walls	X		
	Axial demand on braces in Eccentric Braced Frames	X		
	Column splice forces	X		
	Axial loads on column	X		
	Moments and shears on moment connections	X		
	Compression on vertical boundary elements of steel plate shear walls	X		
	Compression on horizontal boundary elements of steel plate shear walls		X	
	Forces in members of transfer trusses	X		
	All other force-controlled actions ²	X		
Reinforced Concrete	Shear in beams, columns, and beam-column joints of special moment frames	X		
	Shear in columns not part of special moment frames	X		
	Axial load in columns of intentional outrigger systems, or in columns supporting discontinuous vertical elements	X		
	Combined moment and axial load in gravity columns ³	X		
	Shear and moment in transfer girders	X		
	Shear in structural walls that are part of the primary lateral-force-resisting system	X		
	Shear and moment in basement walls		X	
	Shear in coupling beams without special diagonal reinforcing ⁴	X		
	Compression on struts in strut and tie formulations	X		
	Tension on struts in strut and tie formulations		X	
	In-plane shear in transfer diaphragms ⁵	X		
In-plane shear in other diaphragms		X		

Action	Category		
	Critical	Ordinary	Non-critical
Force transfer from diaphragms to vertical elements of the seismic-force-resisting system, including collector forces and shear-friction between diaphragms and vertical elements	X		
In-plane normal forces in diaphragms other than collectors ⁶		X	
Shear in shallow foundation elements, including spread footings and mat foundations	X		
Moment in shallow foundation elements, including spread footings and mat foundations		X	
All other force-controlled actions ²	X		

¹Structural steel elements designed and detailed to conform to the prescriptive requirements of AISC 341 and AISC 358 need not be evaluated in accordance with the criteria for force-controlled elements.

²Other force-controlled items should be categorized considering the criticality of the action to the overall building performance. The default category is shown as Critical.

³As an alternative, column flexure combined with axial force can be modeled as a deformation-controlled action if appropriately detailed.

⁴Coupling beam shear may be considered an ordinary action only if the consequence of element failure is minimal.

⁵Where walls beneath transfer diaphragms are adequate to provide required lateral force resistance in the event of diaphragm failure, transfer diaphragms may be treated as ordinary force-controlled actions.

⁶Diaphragm chord forces fall into this category.

The Pacific Earthquake Engineering Research Center (PEER) is a multi-institutional research and education center with headquarters at the University of California, Berkeley. Investigators from over 20 universities, several consulting companies, and researchers at various state and federal government agencies contribute to research programs focused on performance-based earthquake engineering.

These research programs aim to identify and reduce the risks from major earthquakes to life safety and to the economy by including research in a wide variety of disciplines including structural and geotechnical engineering, geology/seismology, lifelines, transportation, architecture, economics, risk management, and public policy.

PEER is supported by federal, state, local, and regional agencies, together with industry partners.



PEER Core Institutions:
University of California, Berkeley (Lead Institution)
California Institute of Technology
Oregon State University
Stanford University
University of California, Davis
University of California, Irvine
University of California, Los Angeles
University of California, San Diego
University of Southern California
University of Washington

PEER reports can be ordered at http://peer.berkeley.edu/publications/peer_reports.html or by contacting

Pacific Earthquake Engineering Research Center
University of California, Berkeley
325 Davis Hall, Mail Code 1792
Berkeley, CA 94720-1792
Tel: 510-642-3437
Fax: 510-642-1655
Email: peer_center@berkeley.edu

ISSN 1547-0587X



PEER

Report No. 2017/06

May 2017

<http://peer.berkeley.edu>